



POLARTEK DUAL



EEAC334B

**R1234YF/R134a Refrigerant
Recovery/ Recycle / Recharge
Service Vehicle A/C System**

PARTS MANUAL

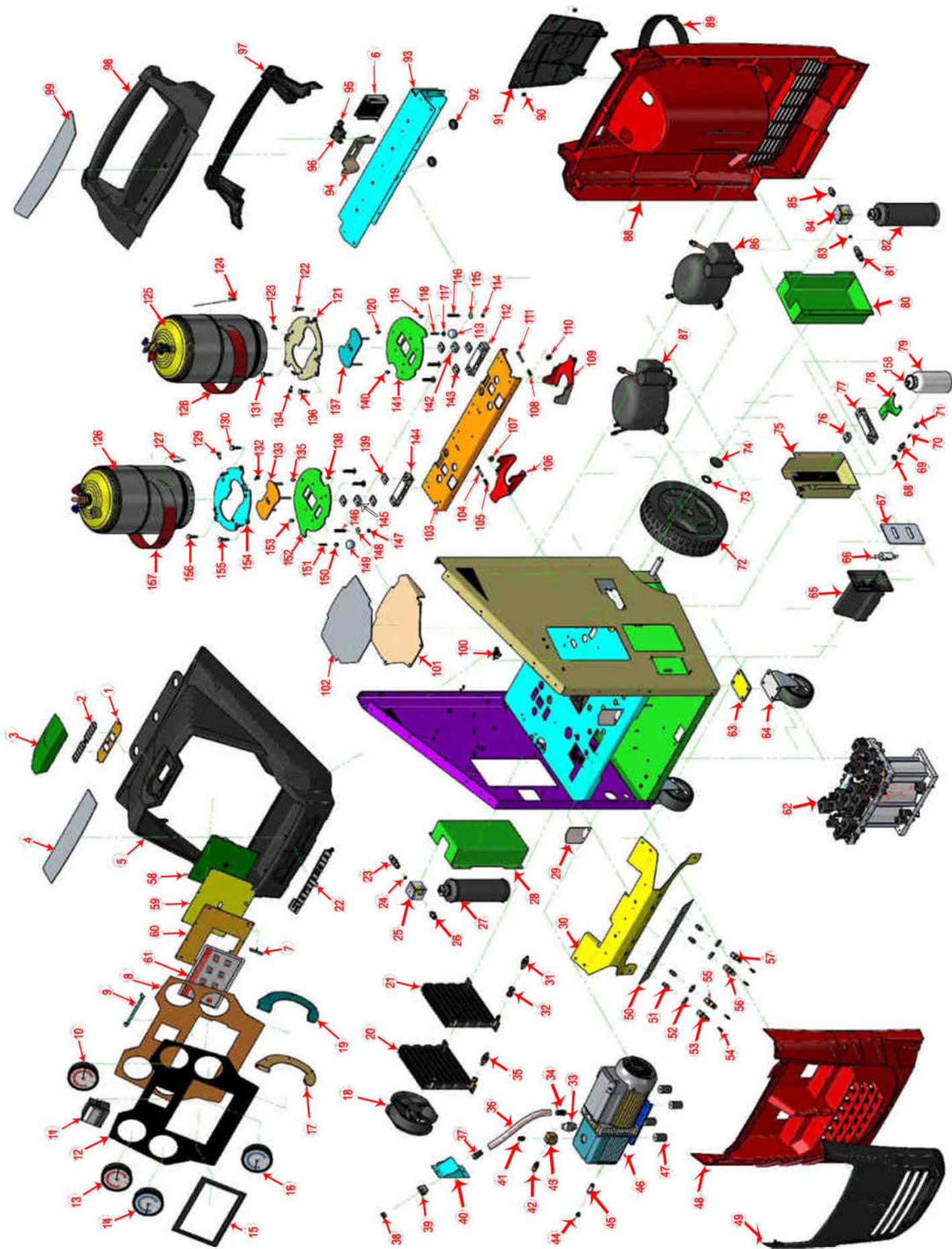

REF#	SNAP-ON PART #	DESCRIPTION
1	CRP5093	LED LIGHT SUPPORT PLATE
2	EEAC331-18	LED LIGHT MOTHERBOARD
3	EEAC334-31	TRANSPARENT LED COVER
4	EEAC334-6	FRONT TOOL TRAY MAT POCKET
5	EEAC334-33	UPPER PLASTIC CARTER
6	EEAC330B-12	POWER SUPPLY 12V
7	EEAC330B-11	WIFI ANTENNA
8	CRP5063	CONTROL PANEL AND SHEET METAL
9	CRP5084	CONTROL PANEL FIXING PLATE
10	EEAC334-29	R1234YF HP 100MM GAUGE
11	GRSTM0007D	PRINTER
12	ADE6690	CONTROL PANEL STICKER
13	EEAC334-29	R134A HP 100MM GAUGE
14	EEAC334-30	R134A LP 100MM GAUGE
15	EEAC334-10	10" DISPLAY FRAME
16	EEAC334-30	R1234YF LP 100MM GAUGE
17	CRP5086	CONTROL PANEL LEFT HINGE
18	EEAC334-80	FAN FOR CONDENSER
19	CRP5085	CONTROL PANEL RIGHT HINGE
20	EEAC333-9	R1234YF CONDENSER (WITHOUT FAN)
21	EEAC334-25	R134A CONDENSER (WITHOUT FAN)
22	EEAC334-32	SNAP-ON BADGE
23	EEAC330-83	3/8SAE CHECK VALVE
24	EEAC334-41	1/8GAS FILTER FITTING
25	EEAC330-96	DRYER FILTER ALUMINIUM MANIFOLD
26	EEAC330-97	NIPPLE 1/8GAS-3/8SAE
27	EEAC330-23B	R134A DRYER FILTER
28	CRP5080	DRYER FILTER SHEET METAL SUPPORT
29	CRP5091	SERVICE HOSES EXIT SHEET METAL
30	CRP5087	FRONT SHEET METAL HINGE SUPPORT
31	EEAC330-82	1/4SAE CHECK VALVE
32	EEAC330-54	DOUBLE PIPE UNION 1/4-1/4SAE
33	EEAC334-42	10MM ELBOW FITTING
34	EEAC334-43	HOSE FITTING 16MM
35	EEAC330-82	1/4SAE CHECK VALVE
36	EEAC334-44	OIL PUMP FILLING HOSE

REF#	SNAP-ON PART #	DESCRIPTION
37	EEAC334-45	HOSE FITTING 16MM
38	EEAC334-46	OIL PUMP FILLING CAP
39	EEAC334-47	MOUNT ADAPTER FITTING
40	CRP5088	OIL PUMP FILLING BRACKET
41	EEAC334-48	6MM ELBOW FITTING
42	EEAC330-85	SAFETY VALVE 1/8GAS 1BAR
43	RAC8100-OT	FITTING M33X1,5 - 1/8GAS
44	EEAC334-49	OIL DRAIN CAP
45	EEAC334-50	OIL DRAIN EXTENSION
46	EEAC334-11	VACUUM PUMP
47	EEAC334-13	ANTI VIBRATION RUBBER
48	EEAC334-34	FRONT PLASTIC COVER
49	EEAC334-35	FRONT PLASTIC POCKET
50	ADE6691	FRONT CONNECTION STICKER
51	EEAC330-93	NIPPLE 1/8GAS-1/4SAE
52	N/A	M16 NUT
53	EEAC332-4	R134A LP QUICK FITTING
54	EEAC332-2	SCHRADER VALVE
50	ADE6691	FRONT CONNECTION STICKER
51	EEAC330-93	NIPPLE 1/8GAS-1/4SAE
52	N/A	M16 NUT
53	EEAC332-4	R134A LP QUICK FITTING
54	EEAC332-2	SCHRADER VALVE
55	EEAC332-3	R134A HP QUICK FITTING
56	EEAC333-10	R1234YF HP QUICK FITTING
57	EEAC333-11	R1234YF LP QUICK FITTING
58	EEAC334B-8	MOTHERBOARD NEVO PLUS W/O DISPLAY
N/S	EEAC334B-11	MOTHERBOARD NEVO PLUS W DISPLAY
59	EEAC334B-1	MOTHERBOARD SUPPORT PLATE
60	CRP5066	DISPLAY SUPPORT PLATE
61	EEAC334-74	10" DISPLAY
62	EEAC334B-2	MANIFOLD DUAL 12V
63	CRP5024	FRONT CASTER SPACER
64	EEAC330-59	FRONT CASTER WITH BRAKE
65	EEAC334-21	GAS ANALYZER
66	EEAC333-8	GAS ANALYZER FILTER

REF#	SNAP-ON PART #	DESCRIPTION
67	EEAC333A-3	GAS ANALYZER TRANSPARENT COVER
68	EEAC800-15	1/4SAE NUT
69	EEAC334-52	MOUNT ADAPTER 1/4SAE FITTING
70	EEAC330-50	SCHRADER VALVE
71	EEAC330-28	1/4SAE TAP
72	EEAC334-17	300MM REAR WHEEL WITH BEARING
73	EEAC330-61	REAR WHEEL RETAINER
74	EEAC330-67	REAR WHEEL CAP
75	CRP5082	USED OIL SHEET METAL SUPPORT
76	EEAC330-100	SCALE SPACER 10MM
77	EEAC330-10	USED OIL SCALE - 15KG
78	EEAC334-53	USED OIL CONTAINER SUPPORT
79	EEAC334-22	USED OIL CONTAINER 500 ML
80	CRP5080	DRYER FILTER SHEET METAL SUPPORT
81	EEAC330-83	3/8SAE CHECK VALVE
82	EEAC330-23B	R1234YF DRYER FILTER
83	EEAC334-41	1/8GAS FILTER FITTING
84	EEAC330-96	DRYER FILTER ALUMINUM MANIFOLD
85	EEAC330-97	NIPPLE 1/8GAS-3/8SAE
86	EEAC333-19	R1234YF COMPRESSOR
87	EEAC330B-5	R134A COMPRESSOR
88	EEAC334-36	REAR PLASTIC COVER
89	EEAC334-9	VIRGIN TANK STRAP
90	EEAC330-99	MAGNET FLARED HOLE CSN-13
91	EEAC334-37 W/O MAGNETS EEAC330-99)	VIRGIN TANK PLASTIC DOOR
92	EEAC330-68	PROTECTION VIRGIN TANK HOSE OUTLET
93	CRP5089	REAR SHEET METAL SUPPORT
94	CRP5071	MAIN SWITCH SHEET METAL SUPPORT
95	EEAC330-18	CABLE GUIDE FOR POWER CABLE
96	EEAC330-19	MAIN SWITCH (CIRCUIT BREAKER)
97	EEAC334-39	PLASTIC HANDLE REINFORCEMENT
98	EEAC334-38	PLASTIC HANDLE + REAR TOOL TRAY
99	EEAC334-7	REAR TOOL TRAY MAT POCKET
96	EEAC330-19	MAIN SWITCH (CIRCUIT BREAKER)
97	EEAC334-39	PLASTIC HANDLE REINFORCEMENT
98	EEAC334-38	PLASTIC HANDLE + REAR TOOL TRAY
99	EEAC334-7	REAR TOOL TRAY MAT POCKET
100	EEAC330-21	USB PORT
101	CRP5075	VIRGIN TANK SHEET METAL SUPPORT
102	EEAC334-8	VIRGIN TANK MAT
103	CRP5079	TANK SHEET METAL SUPPORT

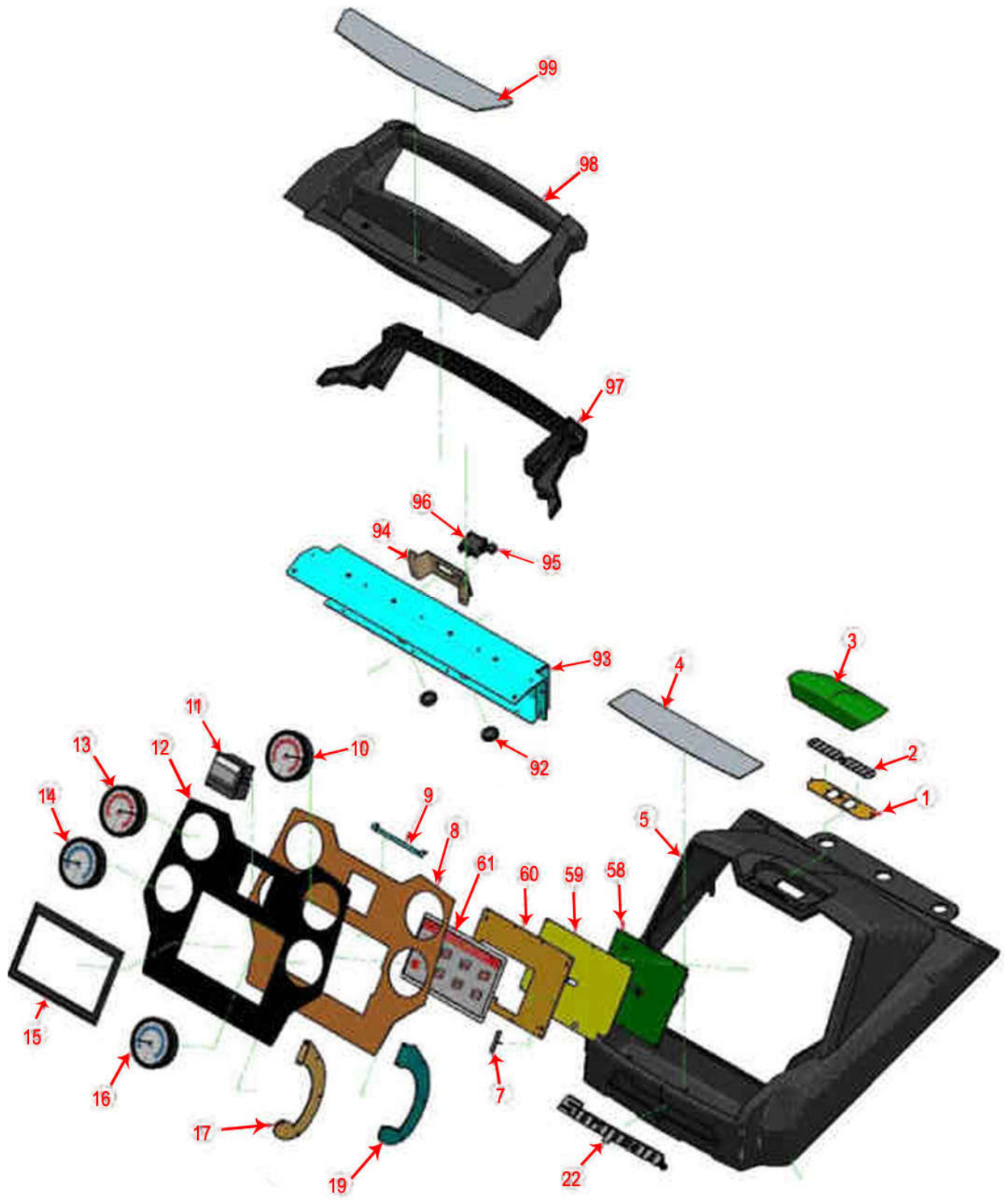

REF#	SNAP-ON PART #	DESCRIPTION
1	CRP5093	LED LIGHT SUPPORT PLATE
2	EEAC331-18	LED LIGHT MOTHERBOARD
3	EEAC334-31	TRANSPARENT LED COVER
4	EEAC334-6	FRONT TOOL TRAY MAT POCKET
5	EEAC334-33	UPPER PLASTIC CARTER
6	EEAC330B-12	POWER SUPPLY 12V
7	EEAC330B-11	WIFI ANTENNA
8	CRP5063	CONTROL PANEL AND SHEET METAL
9	CRP5084	CONTROL PANEL FIXING PLATE
10	EEAC334-29	R1234YF HP 100MM GAUGE
11	GRSTM0007D	PRINTER
12	ADE6690	CONTROL PANEL STICKER
13	EEAC334-29	R134A HP 100MM GAUGE
14	EEAC334-30	R134A LP 100MM GAUGE
15	EEAC334-10	10" DISPLAY FRAME
16	EEAC334-30	R1234YF LP 100MM GAUGE
17	CRP5086	CONTROL PANEL LEFT HINGE
18	EEAC334-80	FAN FOR CONDENSER
19	CRP5085	CONTROL PANEL RIGHT HINGE
22	EEAC334-32	SNAP-ON BADGE
58	EEAC334B-8	MOTHERBOARD NEVO PLUS W/O DISPLAY
N/S	EEAC334B-11	MOTHERBOARD NEVO PLUS W/ DISPLAY
59	EEAC334B-1	MOTHERBOARD SUPPORT PLATE
60	CRP5066	DISPLAY SUPPORT PLATE
61	EEAC334-74	10" DISPLAY
92	EEAC330-68	PROTECTION VIRGIN TANK HOSE OUTLET
93	CRP5089	REAR SHEET METAL SUPPORT
94	CRP5071	MAIN SWITCH SHEET METAL SUPPORT
95	EEAC330-18	CABLE GUIDE FOR POWER CABLE
96	EEAC330-19	MAIN SWITCH (CIRCUIT BREAKER)
97	EEAC334-39	PLASTIC HANDLE REINFORCEMENT
98	EEAC334-38	PLASTIC HANDLE + REAR TOOL TRAY

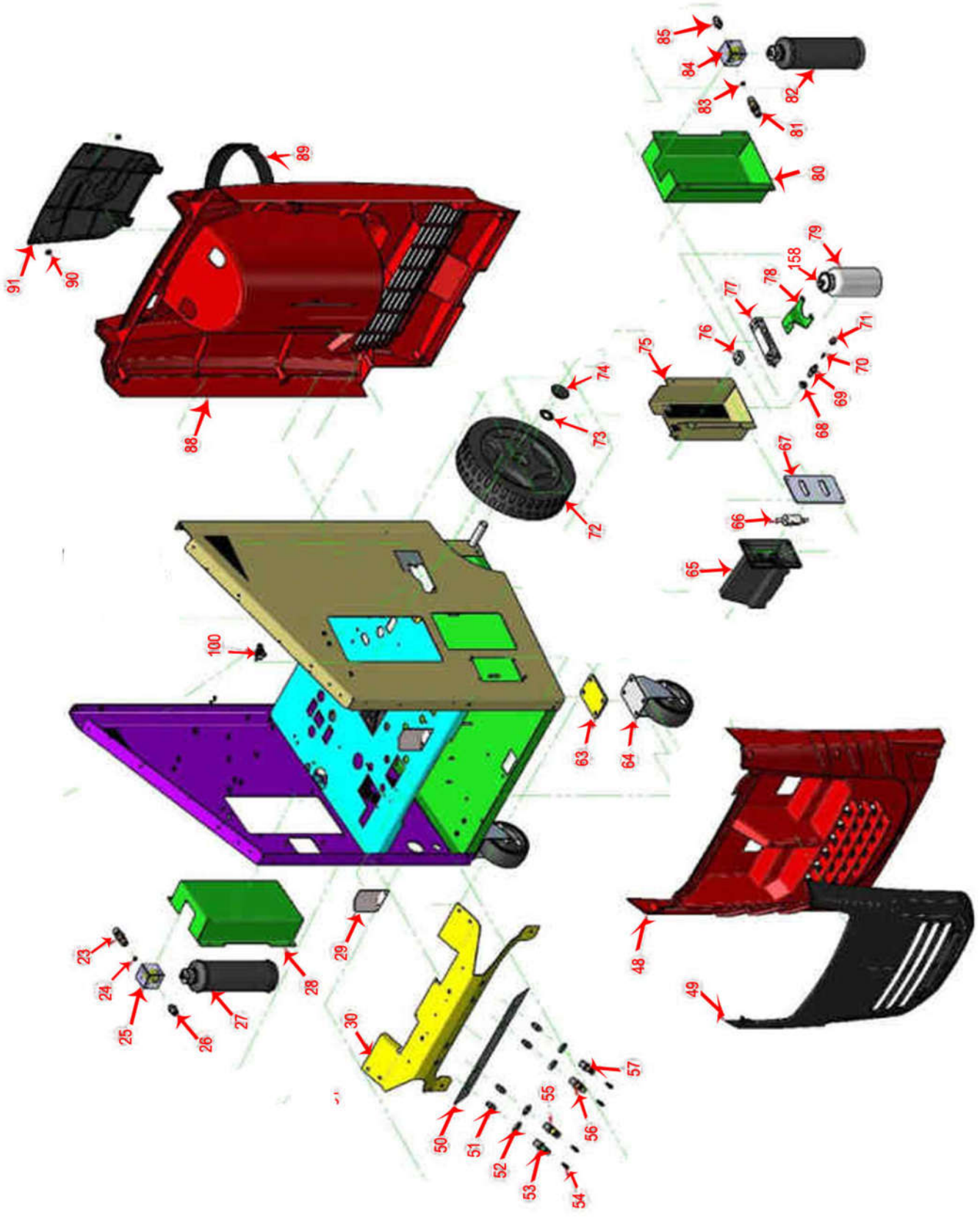

REF#	SNAP-ON PART #	DESCRIPTION
23	EEAC330-83	3/8SAE CHECK VALVE
24	EEAC334-41	1/8GAS FILTER FITTING
25	EEAC330-96	DRYER FILTER ALUMINUM MANIFOLD
26	EEAC330-97	NIPPLE 1/8GAS-3/8SAE
27	EEAC330-23B	R134A DRYER FILTER
28	CRP5080	DRYER FILTER SHEET METAL SUPPORT
29	CRP5091	SERVICE HOSES EXIT SHEET METAL
30	CRP5087	FRONT SHEET METAL HINGE SUPPORT
48	EEAC334-34	FRONT PLASTIC COVER
49	EEAC334-35	FRONT PLASTIC POCKET
50	ADE6691	FRONT CONNECTION STICKER
51	EEAC330-93	NIPPLE 1/8GAS-1/4SAE
52	N/A	M16 NUT
53	EEAC332-4	R134A LP QUICK FITTING
54	EEAC332-2	SCHRADER VALVE
55	EEAC332-3	R134A HP QUICK FITTING
56	EEAC333-10	R1234YF HP QUICK FITTING
57	EEAC333-11	R1234YF LP QUICK FITTING
63	CRP5024	FRONT CASTER SPACER
64	EEAC330-59	FRONT CASTER WITH BRAKE
65	EEAC334-21	GAS ANALYZER
66	EEAC333-8	GAS ANALYZER FILTER
67	EEAC333A-3	GAS ANALYZER TRANSPARENT COVER
68	EEAC800-15	1/4SAE NUT
69	EEAC334-52	MOUNT ADAPTER 1/4SAE FITTING
70	EEAC330-50	SCHRADER VALVE
71	EEAC330-28	1/4SAE TAP
72	EEAC334-17	300MM REAR WHEEL WITH BEARING
73	EEAC330-61	REAR WHEEL RETAINER
74	EEAC330-67	REAR WHEEL CAP
75	CRP5082	USED OIL SHEET METAL SUPPORT
76	EEAC330-100	SCALE SPACER 10MM
77	EEAC330-10	USED OIL SCALE - 15KG
78	EEAC334-53	USED OIL CONTAINER SUPPORT

REF#	SNAP-ON PART #	DESCRIPTION
79	EEAC334-22	USED OIL CONTAINER 500 ML
80	CRP5080	DRYER FILTER SHEET METAL SUPPORT
81	EEAC330-83	3/8SAE CHECK VALVE
82	EEAC330-23B	R1234YF DRYER FILTER
83	EEAC334-41	1/8GAS FILTER FITTING
65	EEAC334-21	GAS ANALYZER
66	EEAC333-8	GAS ANALYZER FILTER
67	EEAC333A-3	GAS ANALYZER TRANSPARENT COVER
68	EEAC800-15	1/4SAE NUT
69	EEAC334-52	MOUNT ADAPTER 1/4SAE FITTING
70	EEAC330-50	SCHRADER VALVE
71	EEAC330-28	1/4SAE TAP
72	EEAC334-17	300MM REAR WHEEL WITH BEARING
73	EEAC330-61	REAR WHEEL RETAINER
74	EEAC330-67	REAR WHEEL CAP
75	CRP5082	USED OIL SHEET METAL SUPPORT
76	EEAC330-100	SCALE SPACER 10MM
77	EEAC330-10	USED OIL SCALE - 15KG
78	EEAC334-53	USED OIL CONTAINER SUPPORT
79	EEAC334-22	USED OIL CONTAINER 500 ML
80	CRP5080	DRYER FILTER SHEET METAL SUPPORT
81	EEAC330-83	3/8SAE CHECK VALVE
82	EEAC330-23B	R1234YF DRYER FILTER
83	EEAC334-41	1/8GAS FILTER FITTING
84	EEAC330-96	DRYER FILTER ALUMINUM MANIFOLD
85	EEAC330-97	NIPPLE 1/8GAS-3/8SAE
88	EEAC334-36	REAR PLASTIC COVER
89	EEAC334-9	VIRGIN TANK STRAP
90	EEAC330-99	MAGNET FLARED HOLE CSN-13
91	EEAC334-37 (DOES NOT COME WITH MAGNETS)	VIRGIN TANK PLASTIC DOOR

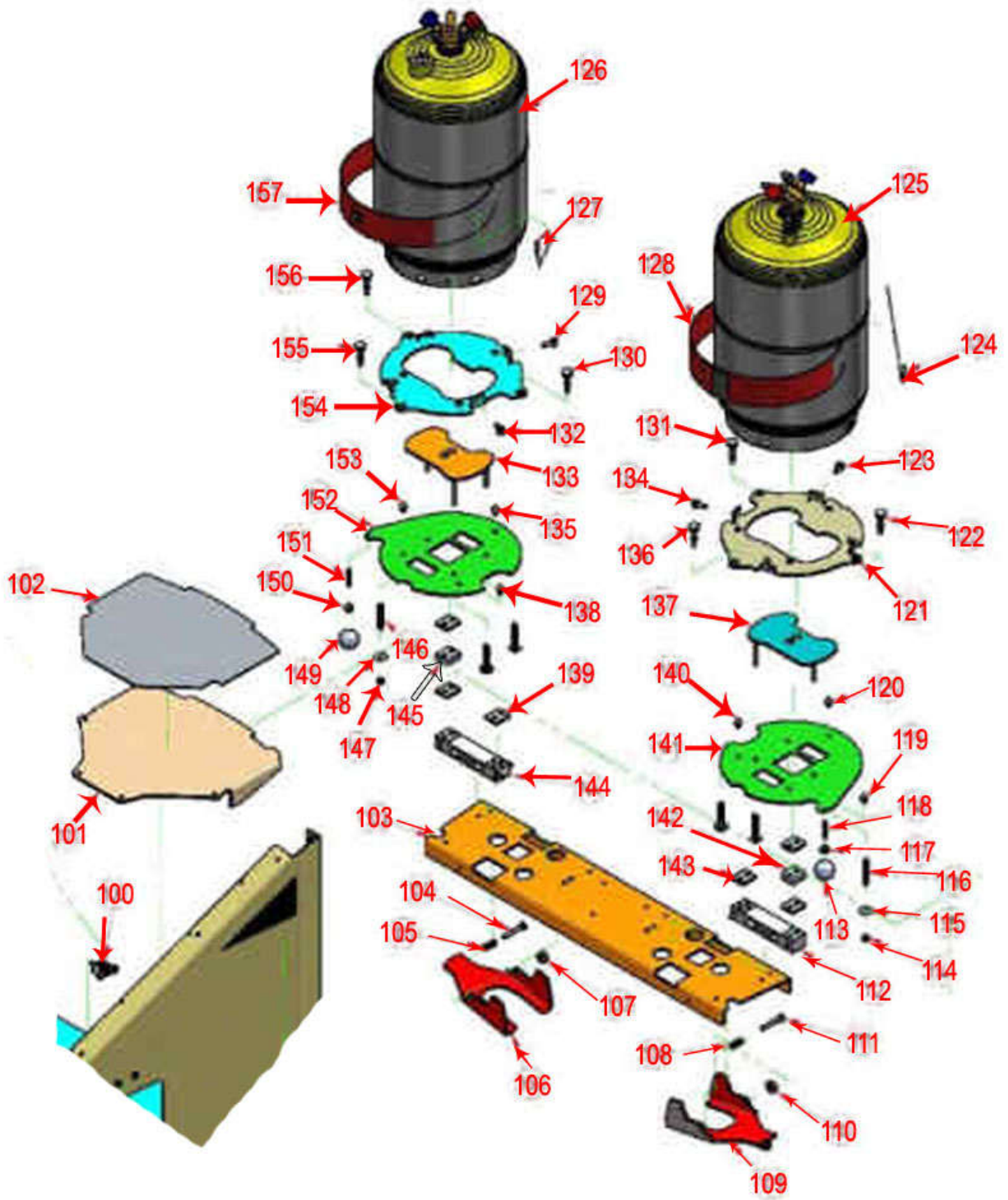

REF#	SNAP-ON PART #	DESCRIPTION
103	CRP5079	TANK SHEET METAL SUPPORT
104	VIT0073	BOLT M6X45
105	EEAC334-55	SPRING MCPC55
106	CRP5067	R134A TANK LEVER
107	RAC6202	SPACER DCB 6MM
108	EEAC334-55	SPRING MCPC55
109	CRP5068	R1234YF TANK LEVER
110	RAC6202	SPACER DCB 6MM
111	VIT0073	BOLT M6X45
112	EEAC330-124	TANK SCALE - 50KG
113	EEAC330-56	REFERENCE WEIGHT BALL
114	VIT0023	M6 NUT FOR COMPRESSION SPRING
115	VIT0004	WASHER FOR COMPRESSION SPRING
116	EEAC334-56	COMPRESSION SPRING
117	EEAC334-14	TANK PLATE GTN-13 MAGNET
118	RAC6108	SPACER M3 35MM
119	EEAC330A-4	TANK PLATE CENTERING PIN
120	EEAC330A-4	TANK PLATE CENTERING PIN
121	CRP5078	R1234YF TANK PLATE2
122	EEAC330A-5	TANK PLATE STOP SCREW
123	VIT0013	TANK FIXING BOLT
124	EEAC330-66	TANK TEMPERATURE PROBE
125	EEAC330-11	R1234YF REFRIGERANT STORAGE TANK
126	EEAC330-11	R134A REFRIGERANT STORAGE TANK
127	EEAC330-66	TANK TEMPERATURE PROBE
128	EEAC330B-2	TANK HEATER
129	VIT0013	TANK FIXING BOLT
130	EEAC330A-5	TANK PLATE STOP SCREW

REF#	SNAP-ON PART #	DESCRIPTION
131	EEAC330A-5	TANK PLATE STOP SCREW
132	VIT0013	TANK FIXING BOLT
133	CRP5072	R134A PLATE SUPPORT
134	VIT0013	TANK FIXING BOLT
135	EEAC330A-4	TANK PLATE CENTERING PIN
136	EEAC330A-5	TANK PLATE STOP SCREW
137	CRP5073	R1234YF PLATE SUPPORT
138	EEAC330A-4	TANK PLATE CENTERING PIN
139	EEAC330-12	SCALE SPACER 4MM
140	EEAC330A-4	TANK PLATE CENTERING PIN
141	CRP5074	R134A/R1234YF TANK PLATE1
142	EEAC330-100	SCALE SPACER 10MM
143	EEAC330-12	SCALE SPACER 4MM
144	EEAC330-124	TANK SCALE - 50KG
145	EEAC330-100	SCALE SPACER 10MM
146	EEAC334-56	COMPRESSION SPRING
147	VIT0023	M6 NUT FOR COMPRESSION SPRING
148	VIT0004	WASHER FOR COMPRESSION SPRING
149	EEAC330-56	REFERENCE WEIGHT BALL
150	EEAC334-14	TANK PLATE GTN-13 MAGNET
151	RAC6108	SPACER M3 35MM
152	CRP5074	R134A/R1234YF TANK PLATE1
153	EEAC330A-4	TANK PLATE CENTERING PIN
154	CRP5077	R134A TANK PLATE2
155	EEAC330A-5	TANK PLATE STOP SCREW
156	EEAC330A-5	TANK PLATE STOP SCREW
157	EEAC330B-2	TANK HEATER

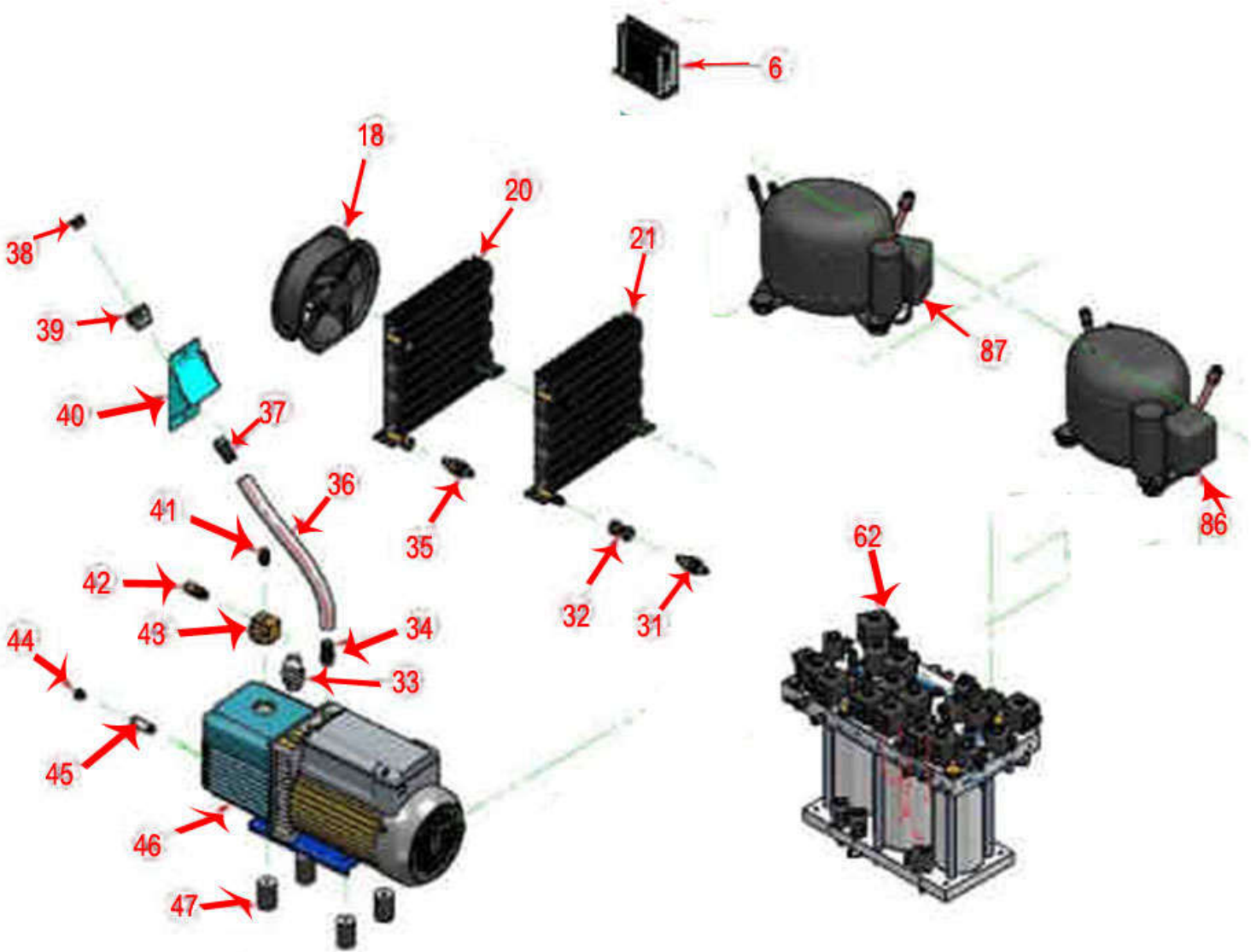

REF#	SNAP-ON PART #	DESCRIPTION
6	EEAC330B-12	POWER SUPPLY 12V
18	EEAC334-80	FAN FOR CONDENSER
20	EEAC333-9	R1234YF CONDENSER (WITHOUT FAN)
21	EEAC334-25	R134A CONDENSER (WITHOUT FAN)
31	EEAC330-82	1/4SAE CHECK VALVE
32	EEAC330-54	DOUBLE PIPE UNION 1/4-1/4SAE
33	EEAC334-42	10MM ELBOW FITTING
34	EEAC334-43	HOSE FITTING 16MM
35	EEAC330-82	1/4SAE CHECK VALVE
36	EEAC334-44	OIL PUMP FILLING HOSE
37	EEAC334-45	HOSE FITTING 16MM
38	EEAC334-46	OIL PUMP FILLING CAP
39	EEAC334-47	MOUNT ADAPTER FITTING
40	CRP5088	OIL PUMP FILLING BRACKET
41	EEAC334-48	6MM ELBOW FITTING
42	EEAC330-85	SAFETY VALVE 1/8GAS 1BAR
43	RAC8100-OT	FITTING M33X1,5 - 1/8GAS
44	EEAC334-49	OIL DRAIN CAP
45	EEAC334-50	OIL DRAIN EXTENSION
46	EEAC334-11	VACUUM PUMP
47	EEAC334-13	ANTIVIBRATION RUBBER
62	EEAC334B-2	MANIFOLD DUAL 12V
86	EEAC333-19	R1234YF COMPRESSOR
87	EEAC330B-5	R134A COMPRESSOR
44	EEAC334-49	OIL DRAIN CAP
45	EEAC334-50	OIL DRAIN EXTENSION
46	EEAC334-11	VACUUM PUMP
47	EEAC334-13	ANTIVIBRATION RUBBER
62	EEAC334B-2	MANIFOLD DUAL 12V
86	EEAC333-19	R1234YF COMPRESSOR
87	EEAC330B-5	R134A COMPRESSOR

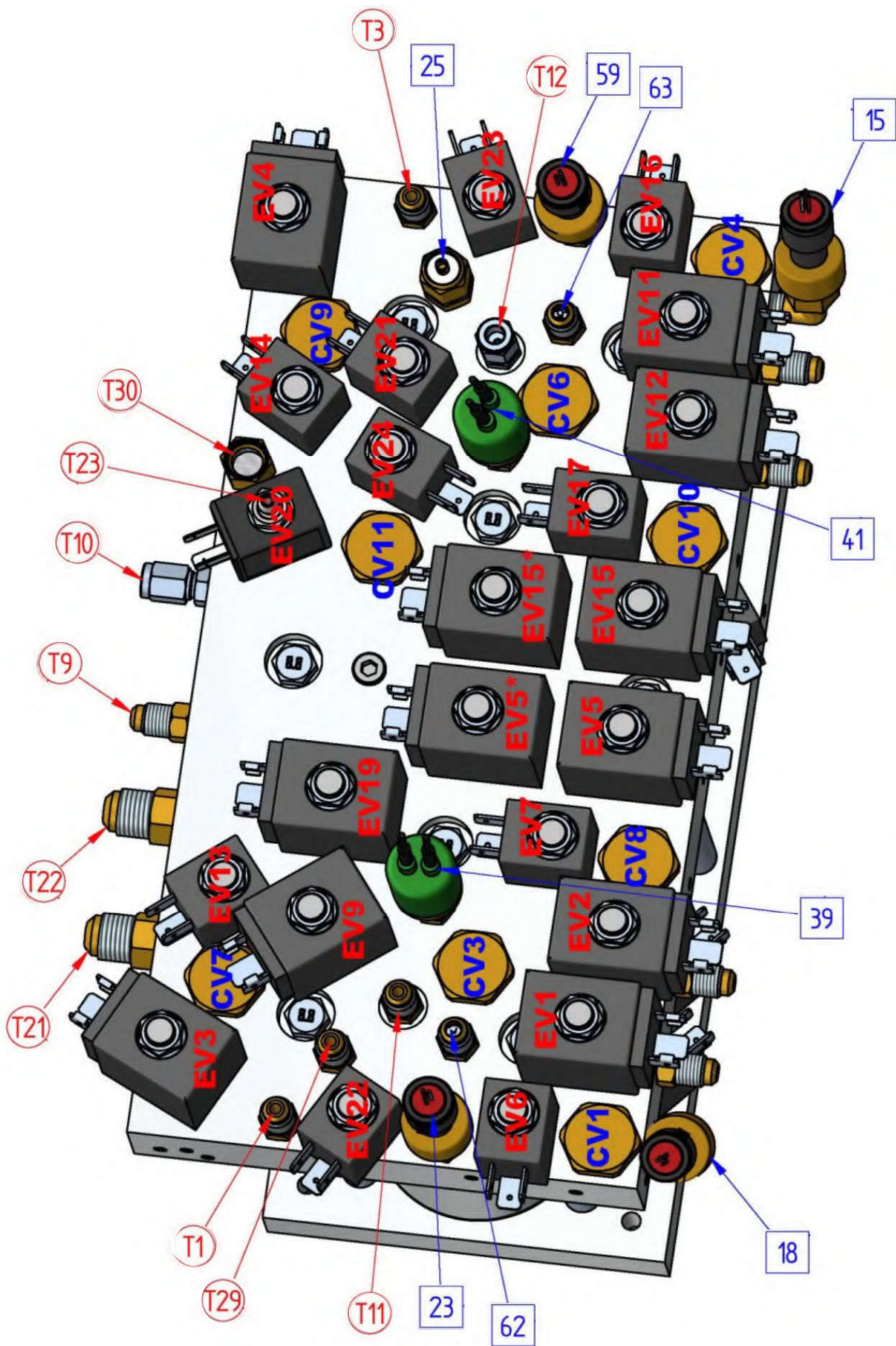

REF#	SNAP-ON PART #	DESCRIPTION
T1	EEAC334-57	EV22 - HP HYBRID FITTING R134A
T3	EEAC334-59	EV23 - HP HYBRID FITTING R1234YF
T9	EEAC334-61	MANIFOLD HEATER - CONDENSER R134A
T10	EEAC334-62	MANIFOLD HEATER - CONDENSER R1234YF
T11	EEAC334-63	COMPRESSOR OUTLET - MANIFOLD OIL SEPARATOR R134A
T12	EEAC334-64	COMPRESSOR OUTLET - MANIFOLD OIL SEPARATOR R1234YF
T21	EEAC334-67	MANIFOLD EV9 - DRYER FILTER R134A
T22	EEAC334-68	MANIFOLD EV19 - DRYER FILTER R1234YF
T23	EEAC330-75	MANIFOLD EV20 UPPER OUTLET - USED OIL TEE FITTING
T29	EEAC330-89	MANIFOLD - CONTAMINATED REFRIGERANT PURGE FITTING
T30	EEAC333-16	MANIFOLD EV24 - GAS ANALYZER
15	EEAC330-69	A/C PRESSURE TRANSDUCER R1234YF
18	EEAC330-69	A/C PRESSURE TRANSDUCER R134A
23	EEAC330-69	BOTTLE PRESSURE TRANSDUCER R134A
25	EEAC330-83	SAFETY VALVE (12BAR)
39	EEAC334-12	SAFETY PRESSURE SWITCH (25 BAR) R134A
41	EEAC334-12	SAFETY PRESSURE SWITCH (25 BAR) R1234YF
59	EEAC330-69	BOTTLE PRESSURE TRANSDUCER R1234YF
62	EEAC334-69	SERVICE TEST CONNECTION R134A
63	EEAC334-69	SERVICE TEST CONNECTION R1234YF
EV1	ELT1171	R134A HIGH PRESSURE ELECTRONIC VALVE
EV1A	VLV1170	R134A HIGH PRESSURE SPOOL VALVE
EV2	ELT1171	R134A LOW PRESSURE ELECTRONIC VALVE
EV2A	VLV1170	R134A LOW PRESSURE SPOOL VALVE
EV3	ELT1171	R134A INLET VACUUM PUMP ELECTRONIC VALVE
EV3A	VLV1170	R134A INLET VACUUM PUMP SPOOL VALVE
EV4	ELT1171	R1234YF INLET VACUUM PUMP ELECTRONIC VALVE
EV4A	VLV1170	R1234YF INLET VACUUM PUMP SPOOL VALVE
EV5	ELT1171	R134A EVAPORATOR ELECTRONIC VALVE
EV5A	VLV1170	R134A EVAPORATOR SPOOL VALVE
EV5*	ELT1171	R134A EVAPORATOR ELECTRONIC VALVE
EV5*A	VLV1170	R134A EVAPORATOR SPOOLVALVE
EV6	ELT1175	R134A REFILLING ELECTRONIC VALVE
EV6A	VLV1175	R134A REFILLING SPOOLVALVE

REF#	SNAP-ON PART #	DESCRIPTION
EV7	ELT1175	R134A EVAPORETOR OVERPRESSURE ELECTRONIC VALVE
EV7A	VLV1175	R134A EVAPORETOR OVERPRESSURE SPOOL VALVE
EV8	ELT1175	R134A OIL COMPRESSOR REFILL ELECTRONIC VALVE
EV8A	VLV1175	R134A OIL COMPRESSOR REFILL SPOOL VALVE
EV9	ELT1171	R134A INLET COMPRESSOR ELECTRONIC VALVE
EV9A	VLV1170	R134A INLET COMPRESSOR SPOOL VALVE
EV10	ELT1175	OIL DISCHARGE ELECTRONIC VALVE
EV10A	VLV1175	OIL DISCHARGE SPOOL VALVE
EV11	ELT1171	R1234YF HIGH PRESSURE ELECTRONIC VALVE
EV11A	VLV1170	R1234YF HIGH PRESSURE SPOOL VALVE
EV12	ELT1171	R1234YF LOW PRESSURE ELECTRONIC VALVE
EV12A	VLV1170	R1234YF LOW PRESSURE SPOOL VALVE
EV13	ELT1175	R134A VIRGIN TANK ELECTRONIC VALVE
EV13A	VLV1175	R134A VIRGIN TANK SPOOL VALVE
EV14	ELT1175	R1234YF VIRGIN TANK ELECTRONIC VALVE
EV14A	VLV1175	R1234YF VIRGIN TANK SPOOL VALVE
EV15	ELT1171	R1234YF EVAPORATOR ELECTRONIC VALVE
EV15A	VLV1170	R1234YF EVAPORATOR SPOOL VALVE
EV15*	ELT1171	R1234YF EVAPORATOR ELECTRONIC VALVE
EV15*A	VLV1170	R1234YF EVAPORATOR SPOOL VALVE
EV16	ELT1175	R1234YF REFILLING ELECTRONIC VALVE
EV16A	VLV1175	R1234YF REFILLING SPOOL VALVE
EV17	ELT1175	R1234YF EVAPORATOR OVERPRESSURE ELECTRONIC VALVE
EV17A	VLV1175	R1234YF EVAPORATOR OVERPRESSURE SPOOLVALVE
EV18	ELT1175	R1234YF OIL COMPRESSOR REFILL ELECTRONIC VALVE
EV18A	VLV1175	R1234YF OIL COMPRESSOR REFILL ESPOOL VALVE
EV19	ELT1171	R1234YF INLET COMPRESSOR ELECTRONIC VALVE
EV19A	VLV1170	R1234YF INLET COMPRESSOR SPOOL VALVE
EV20	ELT1175	OUTLET VACUUM PUMP ELECTRONIC VALVE
EV20A	VLV1177	OUTLET VACUUM PUMP SPOOL VALVE
EV21	ELT1175	AIR PURGE ELECTRONIC VALVE
EV21A	VLV1175	AIR PURGE ELECTRONIC SPOOL
EV22	ELT1175	R134A HYBRID ELECTRONIC VALVE
EV22A	VLV1175	R134A HYBRID ELECTRONIC SPOOL
EV23	ELT1175	R1234YF HYBRID ELECTRONIC VALVE
EV23A	VLV1175	R1234YF HYBRID ELECTRONIC SPOOL
EV24	ELT1175	GAS ANALYZER ELECTRONIC VALVE
EV24A	VLV1175	GAS ANALYZER ELECTRONIC SPOOL

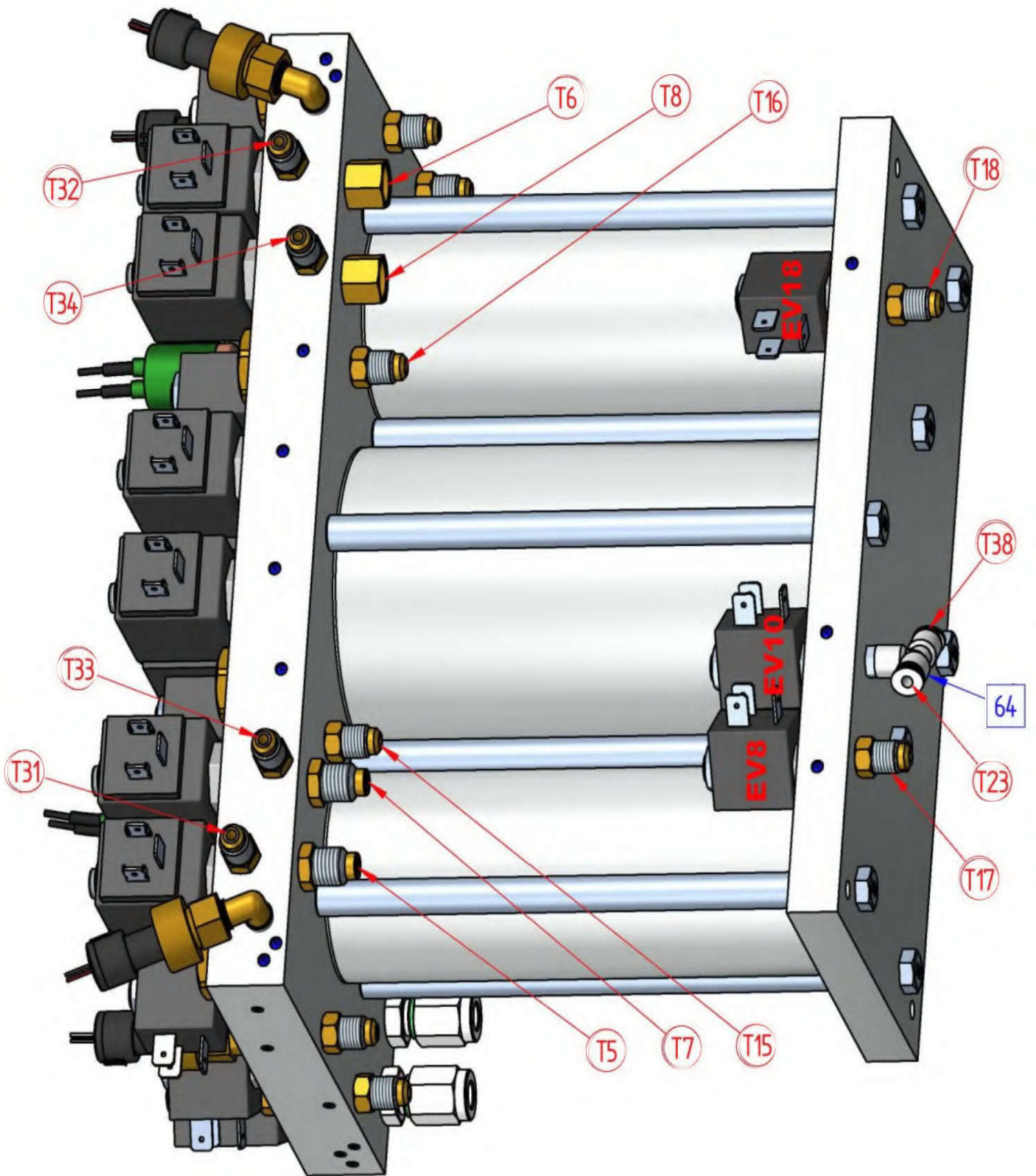

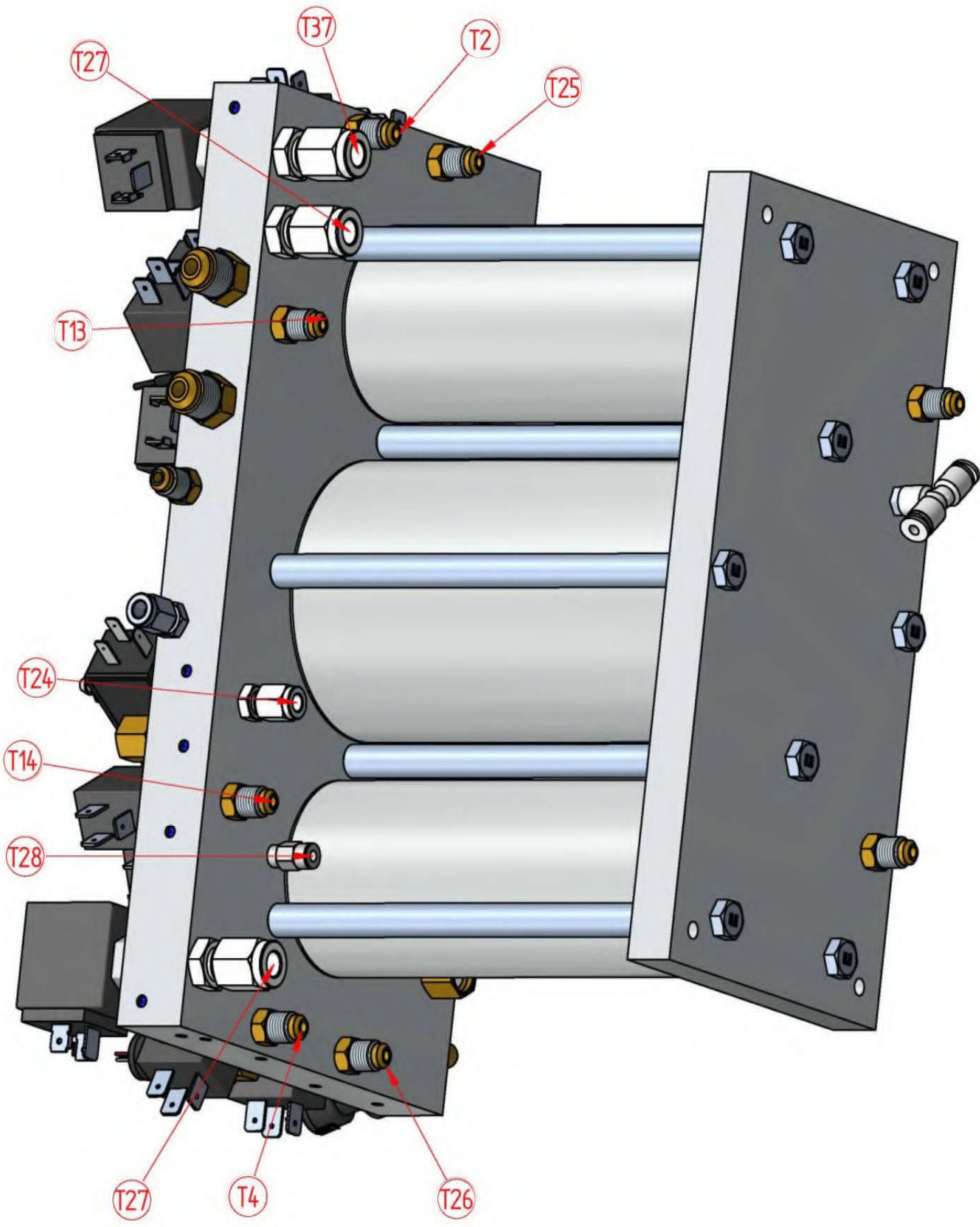

REF#	SNAP-ON PART #	DESCRIPTION
T5	EEAC331-21	MANIFOLD EV1 - HP SERVICE HOSE R134A
T6	EEAC333-13	MANIFOLD EV11 - HP SERVICE HOSE R1234YF
T7	EEAC331-22	MANIFOLD EV2 - LP SERVICE HOSE R134A
T8	EEAC333-12	MANIFOLD EV12 - LP SERVICE HOSE R1234YF
T15	EEAC330-89	MANIFOLD EV7 - 3RD CONNECTION TANK R134A
T16	EEAC330-89	MANIFOLD EV17 - 3RD CONNECTION TANK R1234YF
T17	EEAC330-89	MANIFOLD EV8 - COMPRESSOR R134A
T18	EEAC330-89	MANIFOLD EV18 - COMPRESSOR R1234YF
T23	EEAC330-75	MANIFOLD EV20 UPPER OUTLET - USED OIL TEE FITTING
T32	EEAC330-89	MANIFOLD - HP MANOMETER R1234YF
T33	EEAC330-89	MANIFOLD - LP MANOMETER R134A
T34	EEAC330-89	MANIFOLD - LP MANOMETER R1234YF
T35	EEAC334-27	CONDENSER CK12 - VAPOUR SIDE TANK R134A
T36	EEAC333-28	CONDENSER CK13 - VAPOUR SIDE TANK R1234YF
T37	EEAC330-78	MANIFOLD EV3 - VACUUM PUMP INLET
T38	EEAC330-75	MANIFOLD EV10 - USED OIL CONTAINER
64	EEAC334-71	USED OIL TEE FITTING
T2	EEAC334-58	EV22 - LP HYBRID FITTING R134A
T4	EEAC334-60	EV23 - LP HYBRID FITTING R1234YF
T13	EEAC334-19	MANIFOLD EV13 - VIRGIN TANK R134A
T14	EEAC334-20	MANIFOLD EV14 - VIRGIN TANK R1234YF
T24	EEAC330-77	VACUUM PUMP OUTLET - MANIFOLD EV20 INLET
T25	EEAC330-74	MANIFOLD EV6 - LIQUID SIDE TANK R134A
T26	EEAC333-2	MANIFOLD EV16 - LIQUID SIDE TANK R1234YF
T27	EEAC330-78	MANIFOLD EV3 - EV4 BYPASS
T28	EEAC330-76	MANIFOLD EV21 NCG PURGE
T37	EEAC330-78	MANIFOLD EV3 - VACUUM PUMP INLET

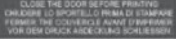















IMAGE	DESCRIPTION	SNAP-ON PART #
	PRINTER STICKER	EEAC331-1
	GROUND STICKER	EEAC330-1
	BOTTLE STICKER R134a	EEAC330-4
	BOTTLE STICKER R1234yf	EEAC333-1
	HIGHSIDE QUICK COUPLE R134a	EEAC330-6
	LOWSIDE QUICK COUPLE R134a	EEAC330-7
	HIGHSIDE QUICK COUPLE R1234yf	EEAC333-3
	LOWSIDE QUICK COUPLE R1234yf	EEAC333-4
	PLOYTUBE 2.5X4 FOR T25	EEAC33-76
	GAS ALAYZER HOSE W/REDUCER	EEAC333-16
	TANK LOAD CELL 50kg	EEAC330-124
	OIL 15kg LOAD CELL	EEAC330-10
	M 1/4 -F 3/8 SAE FITTING	EEAC330-95
	30# REFIG. TANK	EEAC330-11
	BOTTLE SCALE SPACER PLATE	EEAC330-12
	FILTER WRENCH	EEAC330-13

















IMAGE	DESCRIPTION	SNAP-ON PART #
	DRYER FILTER MANIFOLD	EEAC330-96
	FRONT TOOL MAT	EEAC334-6
	REAR TOOL MAT	EEAC334-7
	VIRGIN TANK MAT	EEAC334-8
	VIRGIN TANK STRAP	EEAC334-9
	10" DISPLAY FRAME	EEAC334-10
	VACUUM PUMP	EEAC334-11
	SAFETY PRESSURE SWITCH 25 BAR	EEAC334-12
	RUBBER FEET FOR VAC. PUMP	EEAC334-13
	VAC. PUMP OIL	ACT7-0A
	HP CONNECTOR R134a	EEAC332-3
	LP CONNECTOR R134a	EEAC332-4
	DEPRESSOR VALVE SMALL	EEAC330-50
	DEPRESSOR VALVE BIG	EEAC332-2
	HP CONNECTOR R1234yf	EEAC333-10
	LP CONNECTOR R1234yf	EEAC333-11
	PIPE UNION F 1/4 SAE	EEAC330-54

















IMAGE	DESCRIPTION	SNAP-ON PART #
	BALL VALVE M/F 1/8	EEAC330-55
	CAL. REF. WEIGHT 114gr	EEAC330-56
	SOLENOID COIL FOR	ELT1175
	POWER CABLE 110vac	EEAC330-17
	CABLE GUIDE	EEAC330-18
	MAIN POWER SWITCH W/BREAKER	EEAC330-19
	SOLENOID COIL	ELT1171
	INTERNAL USB CABLE	EEAC330-21
	WIRING CONNECTION FOR EEAC330-69	EEAC330-22
	GAS ANALYZER FILTER	EEAC333-8
	FILTER DRYER	EEAC330-23B
	TANK PLATE CENTERING PIN	EEAC330A-4
	TANK PLATE STOP SCREW	EEAC330A-5
	SOLENOID HARNESS	EEAC334B-4
	GAS NIPPLE 1/8-3/8 SAE	EEAC330-97
	1/4 CAP W/GASKET	EEAC330-28
	CONTROL PANEL W/ SHEET METAL	EEAC334-1









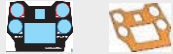







IMAGE	DESCRIPTION	SNAP-ON PART #
	LOCK/UNLOCK STICKER	EEAC334-2
	HIGHSIDE GAUGE	EEAC334-29
	LOWSIDE GAUGE	EEAC334-30
	FRONT CASTER W/BRAKE	EEAC330-59
	20mm WHEEL RETAINER	EEAC330-61
	TANK PLATE MAGNET	EEAC334-14
	DuPONT yf ADP. VIRGIN TANK	EEAC334-15
	UN/LOCK HANDLE	EEAC334-16
	REAR WHEEL W/ BEARING	EEAC334-17
	LED LIGHT BOARD	EEAC331-18
	TEMP. PROBE	EEAC330-66
	THERMAL PRINTER	GRSTM0007D
	THERMAL PAPER	EEAC331-20
	REAR WHEEL CAP	EEAC330-67
	MAGNET FLARED HOLE	EEAC330-99
	PRESSURE TRANSDUCER	EEAC330-69
	100cm COPPER TUBE W/FITTINGS	EEAC330-89















IMAGE	DESCRIPTION	SNAP-ON PART #
	R134a 3.8m RED HOSE	EEAC331-21
	R134a 3.8m BLUE HOSE	EEAC331-22
	HFO BLUE HOSE 95cm W/BALL VALVE	EEAC333A-1
	HFO RED HOSE 95cm W/BALL VALVE	EEAC333A-2
	R134a VIRGIN TANK HOSE	EEAC334-19
	R1234yf VIRGIN TANK HOSE	EEAC334-20
	DUAL GAS ANALYZER	EEAC334-21
	USED OIL BOTTLE 500ml	EEAC334-22
	3.8m HFO BLUE HOSE	EEAC333-12
	3.8m HFO RED HOSE	EEAC333-13
	3X6 OIL HOSE	EEAC330-75
	4X6 HOSE	EEAC330-77
	8X10 HOSE	EEAC330-78
	SOLENOID VALVE	VLV1170
	CHECK VALVE	EEAC330-80

















IMAGE	DESCRIPTION	SNAP-ON PART #
	SOLENOID VALVE	VLV1175
	CHECK VALVE 1/4X1/4	EEAC330-82
	CHECK VALVE 3/8X3/8	EEAC330-83
	12 BAR SAFETY VALVE	EEAC330-84
	1 BAR SAFETY VALVE	EEAC330-85
	3WAY SOLENOID VALVE	VLV1177
	GAS ANALYZER COVER	EEAC333A-3
	10mm SCALE SPACER	EEAC330-100
	REAR PLASTIC COVER	EEAC334-36
	DUST COVER	EEAC334COV
	R134a CONDENSER	EEAC334-25
	R1234yf CONDENSER	EEAC333-9
	110cm BLUE HOSE W/BALL VALVE	EEAC334-27
	110cm BLUE HOSE W/BALL VALVE	EEAC334-28
	HIGH PRESSURE GAUGE	EEAC334-29
	LOW PRESSURE GAUGE	EEAC334-30

















IMAGE	DESCRIPTION	SNAP-ON PART #
	LED LIGHT COVER	EEAC334-31
	SNAP-ON BADGE	EEAC334-32
	UPPER PLASTIC COVER	EEAC334-33
	FRONT PLASTIC COVER	EEAC334-34
	FRONT PLASTIC POCKET	EEAC334-35
	PLASTIC COVER VIRGIN BOTTLE (Does not come with magnets EEAC330-99)	EEAC334-37
	PLASTIC HANDLE W/TOOL TRAY	EEAC334-38
	PLASTIC REINFORCEMENT HANDLE	EEAC334-39
	WARNING STICKER (EN)	EEAC330-102
	WARNING STICKER (FR)	EEAC330-103
	FIRE RISK STICKER (EN)	EEAC333-21
	FIRE RISK STICKER (FR)	EEAC333-23
	FIRE RISK STICKER-2 (EN)	EEAC334-72
	FIRE RISK STICKER-2 (FR)	EEAC334-73
	6mm PLASTIC SPACER	EEAC334-40
	1/8 GAS FILTER FITTING	EEAC334-41
	10mm ELBOW FITTING	EEAC334-42

















IMAGE	DESCRIPTION	SNAP-ON PART #
	16mm HOSE FITTING	EEAC334-43
	VAC. PUMP FILLER HOSE	EEAC334-44
	MOUNT ADAPTER 1/4 SAE	EEAC334-52
	USED OIL SUPPORT	EEAC334-53
	SPRING	EEAC334-55
	COMPRESSION SPRING	EEAC334-56
	MANIFOLD EX9- DRYER FILTER R134a	EEAC334-67
	MANIFOLD EX9- DRYER FILTER R1234yf	EEAC334-68
	SERVICE TEST CONNECTION	EEAC334-69
	USED OIL TEE FITTING	EEAC334-71
	TUBE EV22 HP R134a	EEAC334-57
	TUBE EV22 LP R134a	EEAC334-58
	TUBE EV23 HP R1234yf	EEAC334-59
	TUBE EV23 LP R1234yf	EEAC334-60
	MANIFOLD HEATER-CONDENSER R134a	EEAC334-61
	12Vdc POWER SUPPLY CABLE	EEAC334B-3





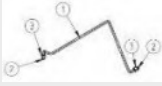











IMAGE	DESCRIPTION	SNAP-ON PART #
	MANIFOLD HEATER-CONDENSER R1234yf	EEAC334-62
	COMPRESSOR OUTLET MANIFOLD OIL SEPARATOR	EEAC334-63
	DRYER FILTER CK2-COMPRESSOR INLET R1234yf	EEAC334-64
	DRYER FILTER CK2-COMPRESSOR INLET R134a	EEAC334-65
	DRYER FILTER CK5-COMPRESSOR INLET R1234yf	EEAC334-66
	POWER SUPPLY (B)	EEAC330B-12
	MOTHERBOARD 10" WITHOUT DISPLAY	EEAC334B-8
	MOTHER BOARD WITH DISPLAY	EEAC334B-11
	FLAT CABLE ADPTER FOR 10" DISPLAY (B)	EEAC334B-9
	WIFI ANTENNA	EEAC330B-11
	FAN WIREING HARNESS	EEAC333-25
	FILTER O-RING KIT (10 PIECES)	EEAC330-81
	O-RING LUBE	EEAC330-109
	NIPPLE 1/8 GAS-1/2 SAE R134a	EEAC333-27
	1/8 GAS 12X1.5mm R1234yf	EEAC333-28
	MESH SCREEN R1234yf	EEAC333-29



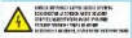













IMAGE	DESCRIPTION	SNAP-ON PART #
	O-RING 1/4 CAP	EEAC330-112
	10" DISPLAY	EEAC334B-74
	EXTENDED BRACKET LIT	EEAC334-77
	SWITCH OFF STICKER	EEAC330-121
	MANUAL VALVE W/DEPRESSOR PIN	EEAC333-32
	GAS ANALYZER HARNESS	EEAC334-78
	1/4 COPPER GASKET	EEAC330-128
	3/8 COPPER GASKET	EEAC330-129
	O2 SENSOR	EEAC333-35
	REAR AXLE	EEAC334-79
	12Vdc CONDENSER FAN	EEAC334-80
	FILTER DRYER	EEAC330-23B
	10" DISPLAY SUPPORT	EEAC334B-1
	MANIFOLD	EEAC334B-2
	TANK HEATER	EEAC330B-2
	PRINTER CABLE	EEAC331B-4

IMAGE	DESCRIPTION	SNAP-ON PART #
	R134a COMPRESSOR	EEAC330B-5
	R1234yf COMPRESSOR	EEAC333-19



Notice: The information contained in this document is subject to change without notice. Snap-on Equipment makes no warranty with regard to this material. Snap-on Equipment shall not be liable for errors contained herein or for incidental consequential damages in connection with furnishings, performance, or use of this material.

This document contains proprietary information which is protected by copyright and patents. All rights are reserved. No part of this document may be photocopied, reproduced, or translated without prior written consent of Snap-on Equipment