



EEAC333B POLARTEK YF

R1234YF Refrigerant Recovery/ Recycle /
Recharge Service Vehicle A/C System



PARTS MANUAL

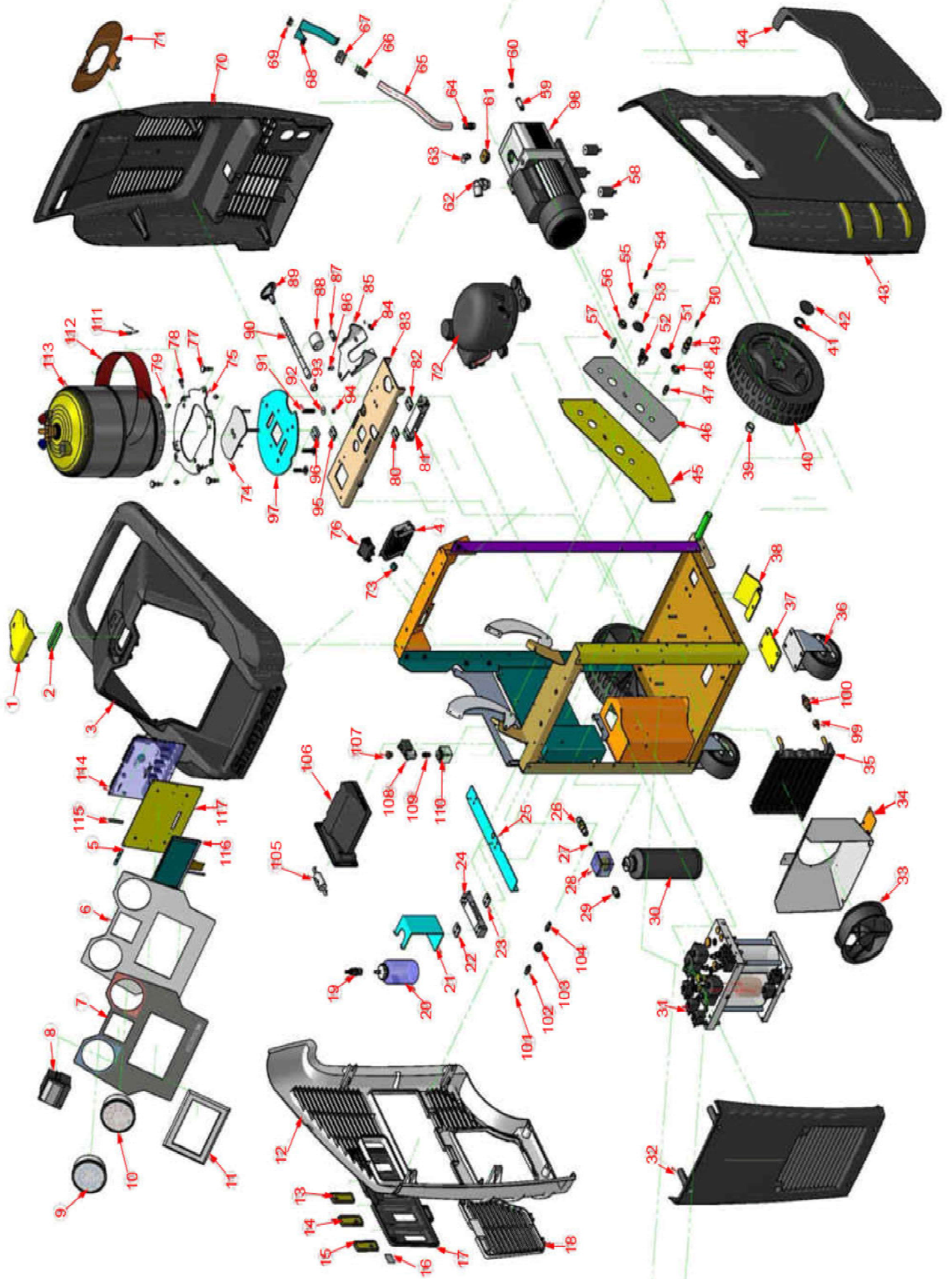

| REF# | PART NUMBER | DESCRIPTION |
|------|-------------|---------------------------------------|
| 1 | EEAC331-12 | TRANSPARENT LED COVER |
| 2 | EEAC331-18 | LED LIGHT MOTHERBOARD |
| 3 | EEAC330-43 | UPPER PLASTIC CARTER |
| 4 | EEAC330B-12 | POWER ADAPTER |
| 5 | EEAC330-119 | CONTROL PANEL FIXING PLATE |
| 6 | EEAC331B-2 | CONTROL PANEL (7" DISPLAY) SHEETMETAL |
| 7 | EEAC333-2 | POLARTEK YF PANEL STICKER |
| 8 | GRSTM0007D | PRINTER |
| 9 | EEAC331-10 | LP 100MM GAUGE |
| 10 | EEAC331-9 | HP 100MM GAUGE |
| 11 | EEAC331B-7 | 7" DISPLAY FRAME |
| 12 | EEAC330-36 | RIGHT PLASTIC COVER |
| 13 | EEAC330-41 | OIL DOOR CAP |
| 14 | EEAC330-41 | OIL DOOR CAP |
| 15 | EEAC330-41 | OIL DOOR CAP |
| 16 | EEAC330-3 | USED OIL GLAZED STICKER |
| 17 | EEAC330-39 | OIL DOOR |
| 18 | EEAC330-40 | FILTER DOOR |
| 19 | EEAC330-57 | USED OIL CONTAINER PLUG - RED |
| 20 | EEAC330-27 | USED OIL CONTAINER - RED CAP |
| 21 | CRP4164-V | USED OIL CONTAINER SUPPORT |
| 22 | EEAC330-12 | SCALE SPACER 4MM |
| 23 | EEAC330-12 | SCALE SPACER 4MM |
| 24 | EEAC330-10 | USED OIL SCALE - 15KG |
| 25 | CRP5036 | OIL SUPPORT BRACKET |
| 26 | EEAC330-83 | 3/8SAE CHECK VALVE |
| 27 | EEAC334-41 | 1/8GAS FILTER FITTING |
| 28 | EEAC330-96 | FILTER MANIFOLD |
| 29 | EEAC330-97 | NIPPLE 1/8GAS-3/8SAE |
| 30 | EEAC330-23B | DRYER FILTER |
| 31 | EEAC333B-1 | MANIFOLD |
| 32 | EEAC330-42 | FRONT PLASTIC COVER |
| 33 | EEAC333-7 | FAN FOR CONDENSER |
| 34 | CRP5022 | FAN AIR DUCT |
| 35 | EEAC333-9 | CONDENSER (WITHOUT FAN) |
| 36 | EEAC330-59 | FRONT CASTER WITH BRAKE |
| 37 | CRP5024 | FRONT CASTER SPACER |
| 38 | CRP4198 | FOOT BRACKET |
| 39 | RAC6020 | REAR WHEEL SPACER |
| 40 | EEAC330-60 | 300MM REAR WHEEL |

| REF# | PART NUMBER | DESCRIPTION |
|------|-------------|-------------------------------|
| 41 | EEAC330-61 | REAR WHEEL RETAINER |
| 42 | EEAC330-67 | REAR WHEEL CAP |
| 43 | EEAC330-35 | LEFT PLASTIC COVER |
| 44 | EEAC330-38 | PLASTIC POCKET |
| 45 | CRP5018 | SIDE CONNECTION PLATE |
| 46 | EEAC331-4 | SIDE CONNECTION STICKER |
| 47 | EEAC330-93 | NIPPLE 1/8GAS-1/4SAE |
| 48 | M16NUT | M16 NUT |
| 49 | EEAC333-10 | HP QUICK FITTING |
| 50 | EEAC332-2 | SCHRADER VALVE |
| 51 | EEAC330-68 | PROTECTION HP HOSE OUTLET |
| 52 | EEAC330-21 | USB PORT |
| 53 | EEAC330-68 | PROTECTION LP HOSE OUTLET |
| 54 | EEAC332-2 | SCHRADER VALVE |
| 55 | EEAC333-11 | LP QUICK FITTING |
| 56 | M16NUT | M16 NUT |
| 57 | EEAC330-93 | NIPPLE 1/8GAS-1/4SAE |
| 58 | EEAC330-49 | ANTIVIBRATION RUBBER |
| 59 | EEAC330-116 | OIL DRAIN EXTENSION |
| 60 | EEAC334-49 | OIL DRAIN CAP |
| 61 | EEAC330-117 | FITTING M24 - 1/8GAS |
| 62 | EEAC334-42 | 10MM ELBOW OGIVE FITTING |
| 63 | EEAC334-48 | 6MM ELBOW OGIVE FITTING |
| 64 | EEAC334-43 | HOSE FITTING 16MM |
| 65 | EEAC334-44 | OIL PUMP FILLING HOSE |
| 66 | EEAC334-45 | HOSE FITTING 16MM |
| 67 | EEAC334-47 | MOUNT ADAPTER FITTING |
| 68 | EEAC330-118 | OIL PUMP FILLING BRACKET |
| 69 | EEAC334-46 | OIL PUMP FILLING CAP |
| 70 | EEAC330-37 | REAR PLASTIC COVER |
| 71 | EEAC330-14 | CORD WRAP |
| 72 | EEAC333B-4 | COMPRESSOR |
| 73 | EEAC330-18 | CABLE GUIDE FOR POWER CABLE |
| 74 | CRP5051 | DAMPER PLATE |
| 75 | CRP5050 | TANK PLATE2 |
| 76 | EEAC330-19 | MAIN SWITCH (CIRCUIT BREAKER) |
| 77 | EEAC330A-5 | TANK PLATE STOP SCREW |
| 78 | VIT0069 | TANK FIXING BOLT |
| 79 | EEAC330A-4 | TANK PLATE CENTERING PIN |
| 80 | EEAC330-12 | SCALE SPACER 4MM |

| REF# | PART NUMBER | DESCRIPTION |
|------|-------------|------------------------------------|
| 81 | EEAC330-124 | TANK SCALE - 50KG |
| 82 | EEAC330-12 | SCALE SPACER 4MM |
| 83 | CRP5048 | MIDDLE LEVEL FRAME REINFORCEMENT |
| 84 | EEAC334-56 | COMPRESSION SPRING |
| 85 | CRP5052 | TANK LOCK LEVER |
| 86 | EEAC330A-6 | THREADED BALL SPRING PLUNGER |
| 87 | RAC5209 | CAM PLATE |
| 88 | RAC5208 | CAM |
| 89 | EEAC330A-3 | TANK LOCK/UNLOCK HANDLE |
| 90 | RAC5206 | LOCK LEVER SHAFT |
| 91 | EEAC334-56 | COMPRESSION SPRING |
| 92 | VIT0004 | WASHER FOR COMPRESSION SPRING |
| 93 | VIT0070 | M12 NUT |
| 94 | VIT0023 | M6 NUT |
| 95 | EEAC330-12 | SCALE SPACER 4MM |
| 96 | EEAC330-100 | SCALE SPACER 10MM |
| 97 | CRP5049 | TANK PLATE1 |
| 98 | EEAC331-13 | VACUUM PUMP |
| 99 | RAC5190 | WELD FITTING 1/4SAE FEMALE |
| 100 | EEAC330-82 | 1/4SAE CHECK VALVE |
| 101 | EEAC330-50 | SCHRADER VALVE |
| 102 | EEAC334-69 | NIPPLE 1/8GAS-1/4SAE FOR VALVE |
| 103 | RAC5600 | MOUNT ADAPTER FITTING |
| 104 | EEAC330-93 | NIPPLE 1/8GAS-1/4SAE |
| 105 | EEAC333-8 | GAS ANALYZER FILTER |
| 106 | EEAC333-18 | GAS ANALYZER |
| 107 | RAC5191 | GAS ANALYZER PRESSURE REDUCER |
| 108 | VLV1461-N-E | GAS ANALYZER ELECTRONIC VALVE |
| 109 | EEAC330-170 | NIPPLE 1/8GAS 1/8GAS |
| 110 | GRDIS1343 | GAS ANALYZER INLET FILTER MANIFOLD |
| 111 | EEAC330-66 | TANK TEMPERATURE PROBE |
| 112 | EEAC330B-2 | TANK HEATER |
| 113 | EEAC330-11 | REFRIGERANT STORAGE TANK |
| 114 | EEAC331B-9 | MOTHERBOARD |
| 115 | EEAC330B-11 | WIFI ANTENNA |
| 116 | EEAC331B-14 | 7" LCD DISPLAY/ SUPPORT |

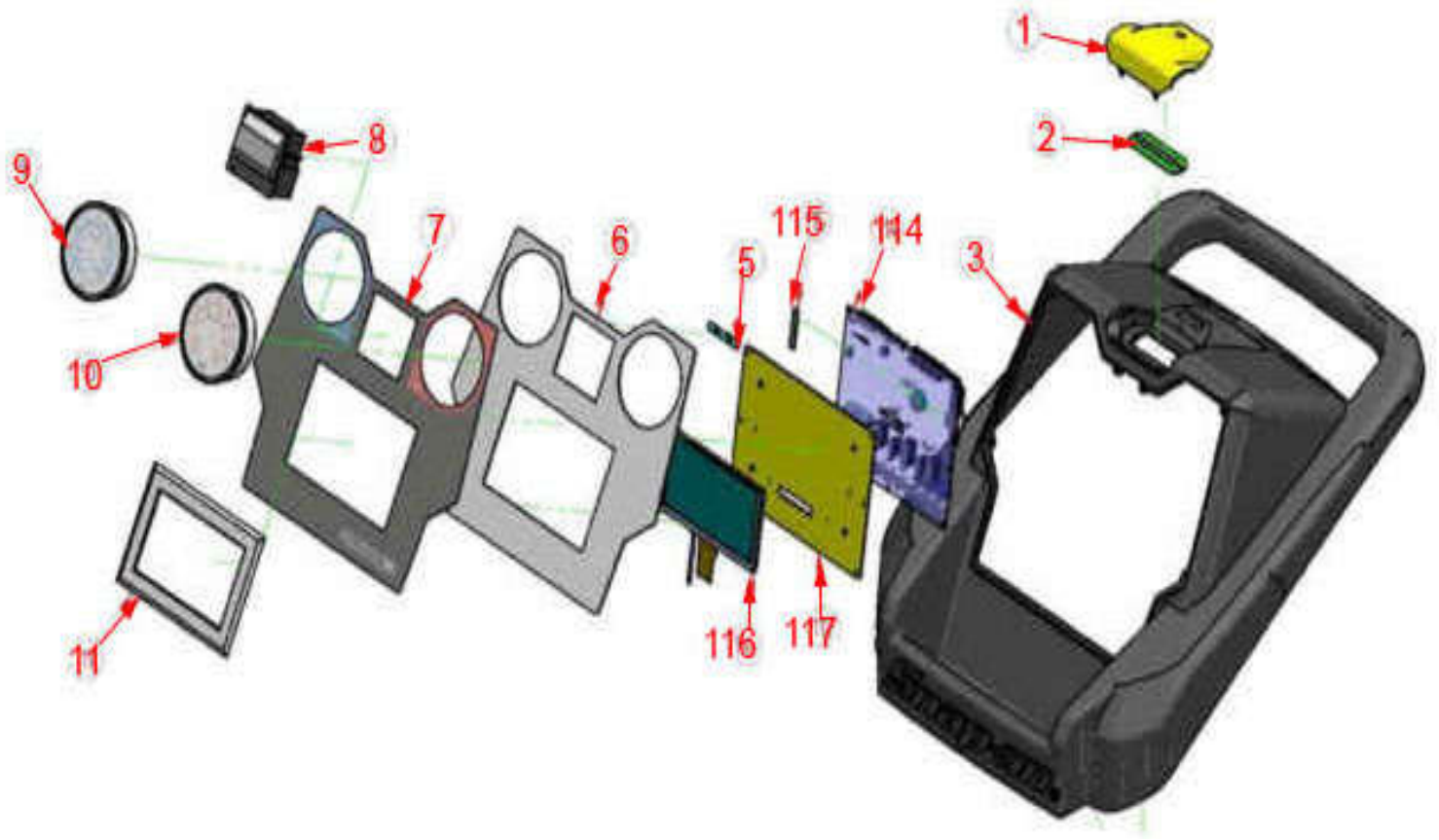

| REF# | PART NUMBER | DESCRIPTION |
|------|-------------|----------------------------|
| 1 | EEAC331-12 | TRANSPARENT LED COVER |
| 2 | EEAC331-18 | LED LIGHT MOTHERBOARD |
| 3 | EEAC330-43 | UPPER PLASTIC CARTER |
| 5 | EEAC330-119 | CONTROL PANEL FIXING PLATE |
| 6 | EEAC331B-2 | CONTROL PANEL (7" DISPLAY) |
| 7 | EEAC333-2 | POLARTEK YF PANEL STICKER |
| 8 | EEAC331-19 | PRINTER |
| 9 | EEAC331-10 | LP 100MM GAUGE |
| 10 | EEAC331-9 | HP 100MM GAUGE |
| 11 | EAC331B-7 | 7" DISPLAY FRAME |
| 114 | EEAC331B-9 | MOTHERBOARD |
| 115 | EEAC330B-11 | WIFI ANTENNA |
| 116 | EEAC331B-14 | 7" LCD DISPLAY W/ SUPPORT |



| REF# | PART NUMBER | DESCRIPTION |
|------|-------------|-------------------------------|
| 4 | EEAC330B-12 | POWER ADAPTER |
| 12 | EEAC330-36 | RIGHT PLASTIC COVER |
| 13 | EEAC330-41 | OIL DOOR CAP |
| 14 | EEAC330-41 | OIL DOOR CAP |
| 15 | EEAC330-41 | OIL DOOR CAP |
| 16 | EEAC330-3 | USED OIL GLAZED STICKER |
| 17 | EEAC330-39 | OIL DOOR |
| 18 | EEAC330-40 | FILTER DOOR |
| 19 | EEAC330-57 | USED OIL CONTAINER PLUG - RED |
| 20 | EEAC330-27 | USED OIL CONTAINER - RED CAP |
| 21 | CRP4164-V | USED OIL CONTAINER SUPPORT |
| 22 | EEAC330-12 | SCALE SPACER 4MM |
| 23 | EEAC330-12 | SCALE SPACER 4MM |
| 24 | EEAC330-10 | USED OIL SCALE - 15KG |
| 25 | CRP5036 | OIL SUPPORT BRACKET |
| 26 | EEAC330-83 | 3/8SAE CHECK VALVE |
| 27 | EEAC334-41 | 1/8GAS FILTER FITTING |
| 28 | EEAC330-96 | FILTER MANIFOLD |
| 29 | EEAC330-97 | NIPPLE 1/8GAS-3/8SAE |
| 30 | EEAC330-23B | DRYER FILTER |
| 32 | EEAC330-42 | FRONT PLASTIC COVER |
| 36 | EEAC330-59 | FRONT CASTER WITH BRAKE |
| 37 | CRP5024 | FRONT CASTER SPACER |
| 38 | CRP4198 | FOOT BRACKET |
| 39 | RAC6020 | REAR WHEEL SPACER |
| 40 | EEAC330-60 | 300MM REAR WHEEL |
| 41 | EEAC330-61 | REAR WHEEL RETAINER |

| REF# | PART NUMBER | DESCRIPTION |
|------|-------------|-------------------------------|
| 42 | EEAC330-67 | REAR WHEEL CAP |
| 43 | EEAC330-35 | LEFT PLASTIC COVER |
| 44 | EEAC330-38 | PLASTIC POCKET |
| 45 | CRP5018 | SIDE CONNECTION PLATE |
| 46 | EEAC331-4 | SIDE CONNECTION STICKER |
| 47 | EEAC330-93 | NIPPLE 1/8GAS-1/4SAE |
| 48 | M16NUT | M16 NUT |
| 49 | EEAC333-10 | HP QUICK FITTING |
| 50 | EEAC332-2 | SCHRADER VALVE |
| 51 | EEAC330-68 | PROTECTION HP HOSE OUTLET |
| 52 | EEAC330-21 | USB PORT |
| 53 | EEAC330-68 | PROTECTION LP HOSE OUTLET |
| 54 | EEAC332-2 | SCHRADER VALVE |
| 55 | EEAC333-11 | LP QUICK FITTING |
| 56 | M16NUT | M16 NUT |
| 57 | EEAC330-93 | NIPPLE 1/8GAS-1/4SAE |
| 70 | EEAC330-37 | REAR PLASTIC COVER |
| 71 | EEAC330-14 | CORD WRAP |
| 73 | EEAC330-18 | CABLE GUIDE FOR POWER CABLE |
| 76 | EEAC330-19 | MAIN SWITCH (CIRCUIT BREAKER) |

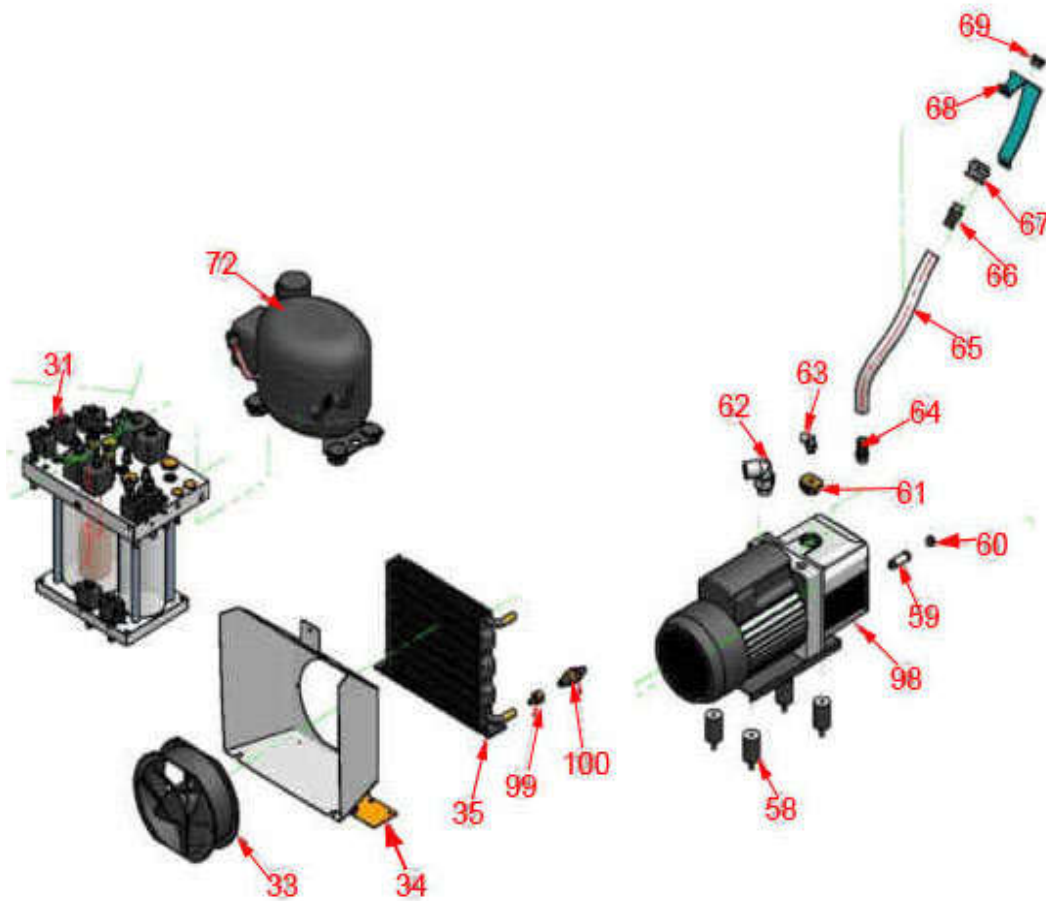

| REF# | PART NUMBER | DESCRIPTION |
|------|-------------|----------------------------|
| 31 | EEAC333B-1 | MANIFOLD |
| 33 | EEAC333-7 | FAN FOR CONDENSER |
| 34 | CRP5022 | FAN AIR DUCT |
| 35 | EEAC333-9 | CONDENSER (WITHOUT FAN) |
| 58 | EEAC330-49 | ANTIVABRION RUBBER |
| 59 | EEAC330-116 | OIL DRAIN EXTENSION |
| 60 | EEAC334-49 | OIL DRAIN CAP |
| 61 | EEAC330-117 | FITTING M24 - 1/8GAS |
| 62 | EEAC334-42 | 10MM ELBOW OGIVE FITTING |
| 63 | EEAC334-48 | 6MM ELBOW OGIVE FITTING |
| 64 | EEAC334-43 | HOSE FITTING 16MM |
| 65 | EEAC334-44 | OIL PUMP FILLING HOSE |
| 66 | EEAC334-45 | HOSE FITTING 16MM |
| 67 | EEAC334-47 | MOUNT ADAPTER FITTING |
| 68 | EEAC330-118 | VAC PUMP FILLING BRACKET |
| 69 | EEAC334-46 | OIL PUMP FILLING CAP |
| 72 | EEAC333B-4 | COMPRESSOR |
| 99 | RAC5190 | WELD FITTING 1/4SAE FEMALE |
| 100 | EEAC330-82 | 1/4SAE CHECK VALVE |

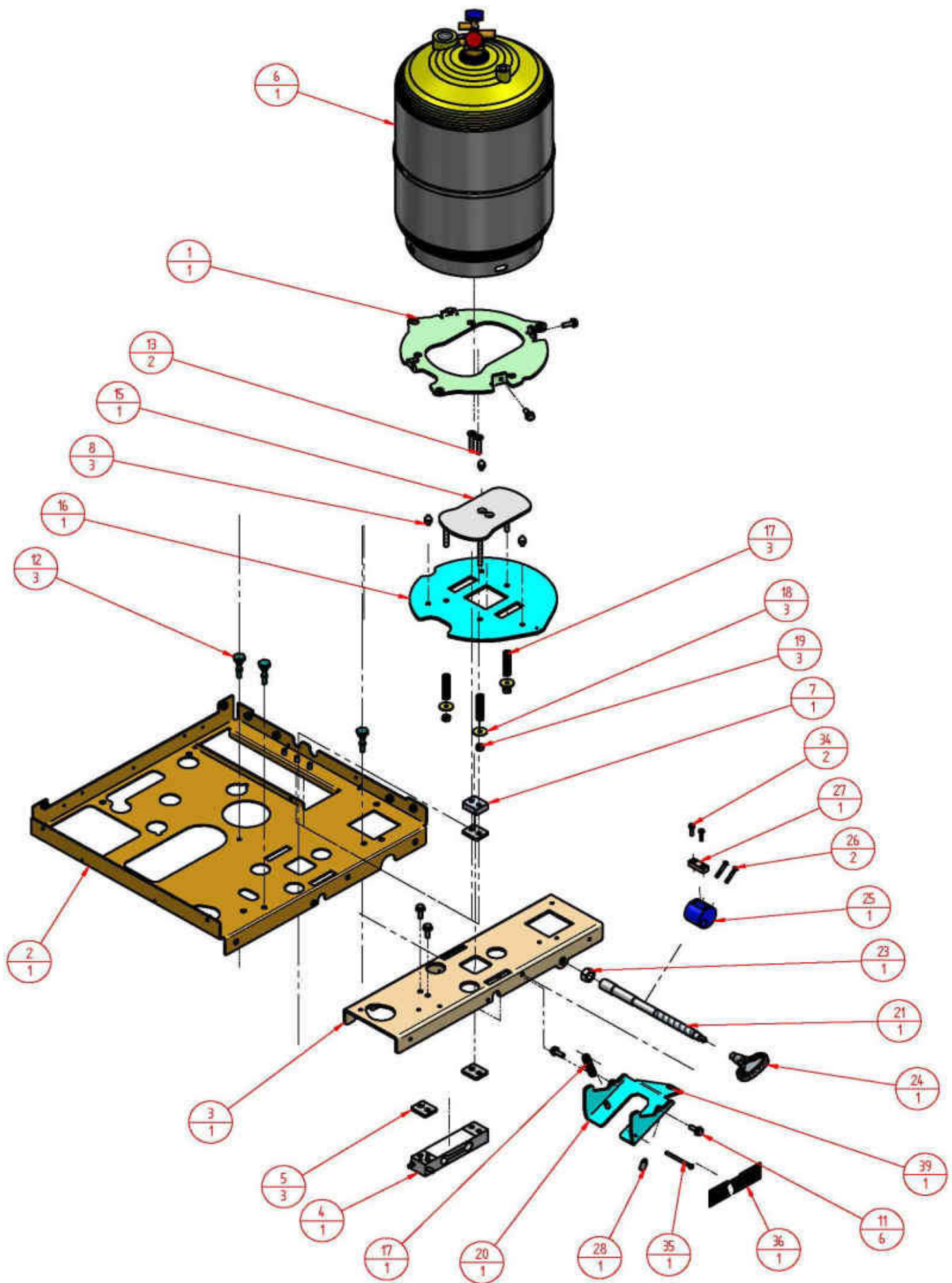



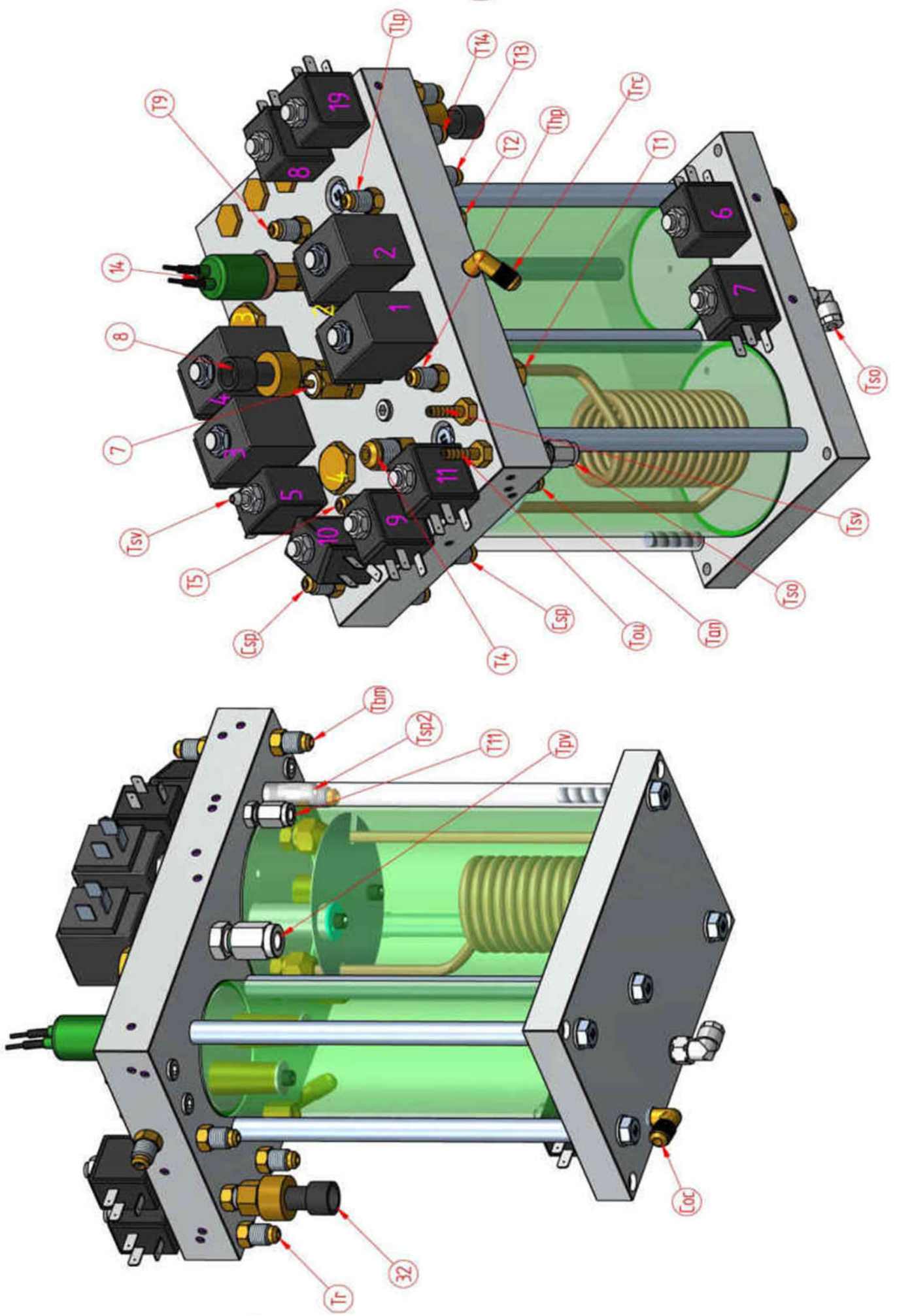







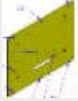





| REF# | PART NUMBER | DESCRIPTION |
|------|-------------|----------------------------------|
| 1 | CRP5050 | TANK PLATE2 |
| 2 | CRP5047 | MIDDLE LEVEL FRAME |
| 3 | CRP5048 | MIDDLE LEVEL FRAME REINFORCEMENT |
| 4 | EEAC330-9 | TANK SCALE - 35KG |
| 5 | EEAC330-12 | SCALE SPACER 4MM |
| 6 | EEAC330-11 | REFRIGERANT STORAGE TANK |
| 7 | EEAC330-100 | SCALE SPACER 10MM |
| 8 | EEAC330A-4 | TANK PLATE CENTRING PIN |
| 11 | VIT0069 | M6 SCREW |
| 12 | EEAC330A-5 | TANK PLATE STOP SCREW |
| 13 | VIT0024 | M6 SCREW |
| 15 | CRP5051 | DUNPER PLATE |
| 16 | CRP5049 | TANK PLATE1 |
| 17 | EEAC334-56 | COMPRESSION SPRING |
| 18 | VIT0004 | WASHER FOR COMPRESSION SPRING |
| 19 | VIT0023 | M6 NUT |
| 20 | CRP5052 | TANK LOCK LEVER |
| 21 | RAC5206 | LOCK LEVER SHAFT |
| 23 | VIT0070 | M12 NUT |
| 24 | EEAC330A-3 | TANK LOCK/UNLOCK HANDLE |
| 25 | RAC5208 | CAM |
| 26 | VIT0064 | M4 SCREW |
| 27 | RAC5209 | CAM PLATE |
| 28 | EEAC330A-6 | THREADED BALL SPRING PLUNGER |
| 34 | VIT0065 | M4 SCREW |
| 35 | VIT0063 | LOCKED/UNLOCKED SCREW |
| 36 | EEAC330A-1 | LOCKED/UNLOCKED STICKER |
| 39 | RACXXXX | THREADED BALL SPRING FITTING |

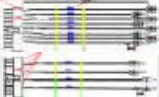



| REF# | PART NUMBER | DESCRIPTION |
|------|-------------|---|
| 1 | ELT1171 | EV1 HIGH PRESSURE SOLENIOD VALVE |
| 1A | VLV1170 | EV1 HIGH PRESSURE SPOOL VALVE |
| 2 | ELT1171 | EV2 LOW PRESSURE SOLENIOD VALVE |
| 2A | VLV1170 | EV2 LOW PRESSURE SPOOL VALVE |
| 3 | ELT1171 | EV3 OUTLET EVAPORATOR SOLENIOD VALVE |
| 3A | VLV1170 | EV3 OUTLET EVAPORATOR SPOOL VALVE |
| 4 | ELT1171 | EV4 INLET VACUUM SOLENIOD VALVE |
| 4A | VLV1170 | EV4 INLET VACUUM SPOOL VALVE |
| 5 | ELT1175 | EV5 OUTLET VACUUM SOLENIOD VALVE |
| 5A | VLV1177 | EV5 OUTLET VACUUM SPOOLVALVE |
| 6 | ELT1175 | EV6 OIL COMPR. REFILL SOLENIOD VALVE |
| 6A | VLV1175 | EV6 OIL COMPRESSOR REFILL SPOOL VALVE |
| 7 | ELT1175 | EV7 OIL DISCHARGE SOLENIOD VALVE |
| 7A | VLV1175 | EV7 OIL DISCHARGE SPOOL VALVE |
| 8 | ELT1175 | EV8 REFILLING SOLENIOD VALVE |
| 8A | VLV1175 | EV8 REFILLING SPOOL VALVE |
| 9 | ELT1175 | EV9 EVAP. OVERPRESSURE SOLENIODVALVE |
| 9A | VLV1175 | EV9 EVAPORATOR OVERPRESSURE SPOOL VALVE |
| 10 | ELT1175 | EV10 AIR PURGE SOLENIOD VALVE |
| 10A | VLV1175 | EV10 AIR PURGE SPOOL VALVE |
| 11 | ELT1175 | EV11 GAS ANALYZER SOLENIOD VALVE |
| 11A | VLV1175 | EV11 GAS ANALYZER SPOOL VALVE |
| 19 | ELT1175 | EV19 WASHING PIPES (HYBRID) |
| 19A | VLV1175 | EV19 WASHING PIPES (HYBRID) |
| 7 | EEAC330-84 | SAFETY VALVE (12BAR) |
| 8 | EEAC330-69 | A/C PRESSURE TRANSDUCER |
| 14 | EEAC330-48 | SAFETY PRESSURE SWITCH (20 BAR) |
| T1 | EEAC331-21 | HIGH PRESSURE FITTING-EV1 |
| T2 | EEAC331-22 | LOW PRESSURE FITTING-EV2 |
| T4 | TUBX085 | EVAPORATOR-FILTER |

















| REF# | PART NUMBER | DESCRIPTION |
|------|-------------|---|
| T5 | TUBX086 | MANIFOLD HEATER-CONDENSER |
| T9 | EEAC330-127 | COMPRESSOR-OIL SEPARATOR |
| T10 | EEAC330-114 | CK1-COMPRESSOR |
| T13 | TUBX067 | EV19-HP MALE COUPLING |
| T14 | TUBX068 | EV19-LP MALE COUPLING |
| TSO | EEAC330-77 | OIL DISCHARGE BYPASS |
| CSP | EEAC330-90 | AIR PURGE BYPASS |
| TSP2 | EEAC330-91 | AIR PURGE BYPASS |
| TB | EEAC330-73 | CONDENSER-REFRIGERANT BOTTLE (LP SIDE) |
| TR | EEAC330-74 | REFRIGERANT BOTTLE (HP SIDE)-MANIFOLD |
| TPV | EEAC330-78 | EV4-VACUUM PUMP |
| TSV | EEAC330-76 | VACUUM PUMP DISCHARGE |
| TOU | EEAC330-76 | MANIFOLD-USED OIL CONTAINER |
| COC | EEAC330-89 | EV6-COMPRESSOR |
| TBM | EEAC330-89 | TANK 3RD CONNECTION - EV9 |
| TLP | EEAC330-89 | MANIFOLD-LP MANOMETER |
| THP | EEAC330-89 | MANIFOLD-HP MANOMETER |
| TRC | EEAC330-89 | MANIFOLD-CONTAMINATED REFRIGERANT FITTING |
| TAN | EEAC330-89 | EV11-GAS ANALYZER |
| T11 | EEAC330-77 | PUMP-EV5 |
| 32 | EEAC330-69 | BOTTLE PRESSURE TRANSDUCER |
| TSP2 | EEAC330-91 | AIR PURGE BYPASS |
| TB | EEAC330-73 | CONDENSER-REFRIGERANT BOTTLE (LP SIDE) |
| TR | EEAC330-74 | REFRIGERANT BOTTLE (HP SIDE)-MANIFOLD |
| TPV | EEAC330-78 | EV4-VACUUM PUMP |
| TSV | EEAC330-76 | VACUUM PUMP DISCHARGE |
| TOU | EEAC330-76 | MANIFOLD-USED OIL CONTAINER |
| COC | EEAC330-89 | EV6-COMPRESSOR |
| TBM | EEAC330-89 | TANK 3RD CONNECTION - EV9 |

















| SNAPON PART NUMBER | IMAGE | DESCRIPTION |
|--------------------|---|----------------------------------|
| EEAC330-1 |  | PRINTER STICKER |
| EEAC330-1 |  | GROUND STICKER |
| EEAC330-3 |  | USED OIL STICKER |
| EEAC333-1 |  | R1234yf BOTTLE STICKER |
| EEAC331-4 |  | SIDE CONNECTION STICKER |
| EEAC332-1 |  | CONTROL PANEL |
| EEAC333-3 |  | HIGHSIDE QUICK COUPLER |
| EEAC333-4 |  | LOWSIDE QUICK COUPLER |
| EEAC333-5 |  | LOWSIDE ADAPTER R1234yf (Dupont) |
| EEAC330-124 |  | LOAD CELL 50Kg |
| EEAC330-10 |  | LOAD CELL 15Kg |
| EEAC330-11 |  | 30lb STORAGE BOTTLE |
| EEAC330-12 |  | SPACER SCALE PLATE |
| EEAC330-13 |  | FILTER WRENCH |
| EEAC330-14 |  | CORD WRAP |
| EEAC330-17 |  | POWER CORD |

| SNAPON PART NUMBER | IMAGE | DESCRIPTION |
|--------------------|---|-------------------------------|
| EEAC331B-1 |  | 7" DISPLAY SHEET METAL |
| EEAC331B-2 |  | CONTROL PANEL SHEET METAL |
| EEAC333-26 |  | MANIFOLD YF |
| EEAC330B-2 |  | TANK HEATER |
| EEAC331B-4 |  | PRINTER CABLE |
| EEAC330B-4 |  | POWER SUPPLY CABLE |
| EEAC333B-4 |  | R134a COMPRESSOR |
| EEAC333-9 |  | CONDENSER W/FAN |
| GRELT050 |  | SOLENOID WIRING HARNESS |
| EEAC331B-7 |  | 7" DISPLAY FRAME |
| EEAC330B-11 |  | WIFI ANTENNA |
| EEAC330B-12 |  | POWER SUPPLY |
| EEAC331B-8 |  | FLAT CABLE DISPLAY ADAPTER |
| EEAC331B-9 |  | NEVOPLUS MOTHER BOARD |
| EEAC331B-14 |  | 7" DISPLAY |
| EEAC331B-11 |  | 50PIN FLAT CABLE (EEAC331B-8) |
| EEAC331B12 |  | 4 PIN FLAT CABLE (EEAC331B-8) |









| SNAPON PART NUMBER | IMAGE | DESCRIPTION |
|--------------------|---|--------------------------|
| EEAC330-18 |  | CABLE GUIDE |
| EEAC330-19 |  | POWER SWITCH W/BREAKER |
| EEAC330-21 |  | USB CABLE |
| EEAC330-22 |  | PRESSURE TRANS. HARNESS |
| EEAC330-23B |  | FILTER DYER |
| EEAC330-27 |  | USED OIL BOTTLE |
| EEAC330-28 |  | F1/4 CAP W/GASKET |
| EEAC330-29 |  | FOAM POCKET |
| EEAC330CVR |  | SINGLE GAS COVER |
| EEAC331-9 |  | HIGHSIDE PRESSURE GAUGE |
| EEAC330-10 |  | LOWSIDE PRESSURE GAUGE |
| EEAC330-35 |  | LEFT SIDE PLASTIC COVER |
| EEAC330-36 |  | RIGHT SIDE PLASTIC COVER |
| EEAC330-37 |  | REAR PLASTIC COVER |
| EEAC330-38 |  | SIDE POCKET |
| EEAC330-39 |  | OIL DOOR |

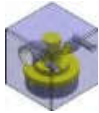











| SNAPON PART NUMBER | IMAGE | DESCRIPTION |
|--------------------|---|-----------------------|
| EEAC330-40 |  | FILTER DOOR |
| EEAC330-41 |  | OIL DOOR CAP |
| EEAC330-42 |  | FRONT PLASTIC COVER |
| EEAC330-43 |  | UPPER PLASTIC COVER |
| EEAC331-11 |  | 7" DISPLAY FRAME |
| EEAC331-12 |  | LED COVER |
| EEAC331-18 |  | LED BOARD |
| GRSTM0007D |  | PRINTER |
| EEAC331-20 |  | THERMAL PRINTER PAPER |
| ELT1045-C |  | ELECTRONIC VALVE |
| ELT1165 |  | ELECTRONIC VALVE |
| VLV1450-N |  | SPOOL VALVE |
| VLV7000 |  | 3 WAY SPOOL VALVE |
| VLV1160-N |  | SPOOL VALVE |
| EEAC330-80 |  | CHECK VALVE |
| EEAC330-55 |  | 1/8 M/F BALL VALVE |

| SNAPON PART NUMBER | IMAGE | DESCRIPTION |
|--------------------|---|------------------------|
| ACT71-0A |  | VACUUM PUMP OIL |
| EEAC331-13 |  | VACUUM PUMP |
| EEAC330-49 |  | RUBBER ISOLATORS |
| EEAC330-48 |  | 20 BAR SAFETY SWITCH |
| EEAC330-69 |  | PRESSURE TRANSDUCER |
| EEAC332-2 |  | BIG DEPRESSOR VALVE |
| EEAC330-50 |  | LITTLE DEPRESSOR VALVE |
| EEAC333-10 |  | HP CONNECTOR R1234yf |
| EEAC333-11 |  | LP CONNECTOR r1234yf |
| EEAC330-54 |  | 1/4 DOUBLE UNION |
| EEAC330-56 |  | CAL. REF. WEIGHT |
| EEAC330-57 |  | RED OIL DRAIN FITTING |
| EEAC330-59 |  | FRONT CASTER W/LOCK |
| EEAC330-60 |  | REAR WHEEL |
| EEAC330-61 |  | REAR WHEEL RETAINER |
| EEAC330-67 |  | REAR WHEEL CAP |
| EEAC330-113 |  | REAR WHEEL AXLE |

| SNAPON PART NUMBER | IMAGE | DESCRIPTION |
|--------------------|---|---------------------------------------|
| EEAC330-66 |  | TEMP. SENSOR |
| EEAC330-68 |  | CABLE GUIDE |
| EEAC330-89 |  | 100cm COPPER HOSE |
| EEAC330-90 |  | 50cm COPPER HOSE |
| EEAC333A-1 |  | 95cm BLUE HOSE W/BALL VALVE |
| EEAC333A-2 |  | 95cm RED HOSE W/BALL VALVE |
| EEAC333-12 |  | 3.8m BLUE HOSE |
| EEAC333-13 |  | 3.8m RED HOSE |
| EEAC333-8 |  | ANALYZER FILTER |
| EEAC333-6 |  | LOWSIDE ADAPTER R1234yf (HONEY WELL) |
| EEAC330-76 |  | 4X2.5 POLY TUBE |
| EEAC330-75 |  | 10m POLY HOSE |
| EEAC330-77 |  | 4X6 POLY HOSE |
| EEAC330-78 |  | 8X10 POLY TUBE |
| EEAC330-116 |  | 10mmX3/8 GAS ELBOW FITTING |
| EEAC333-27 |  | R134a NIPPLE 1/8 GASX 1/2 ACME |

| SNAPON PART NUMBER | IMAGE | DESCRIPTION |
|--------------------|---|---------------------------|
| EEAC330-82 |  | CHECK VALVE M1/4 SAE |
| EEAC330-83 |  | CHECK VALVE M3/8 SAE |
| EEAC330-84 |  | 12 BAR SAFETY VALVE |
| EEAC330-85 |  | 1 BAR SAFETY VALVE |
| EEAC330-93 |  | 1/8 GAS X 1/4 SAE |
| EEAC330-95 |  | M1/4 SAE X 3/8 SAE |
| EEAC330-97 |  | 1/8 GAS X 3/8 SAE |
| EEAC334-48 |  | 6mm ELBOW FITTING |
| EEAC334-41 |  | 1/8 GAS FILTER FITTING |
| EEAC334-43 |  | 16mm HOSE FITTING |
| EEAC334-44 |  | VACUUM PUMP OIL FILL TUBE |
| EEAC334-45 |  | 16mm HOSE FITTING |
| EEAC334-46 |  | OIL FILLING CAAP |
| EEAC334-47 |  | MOUNT ADPATER FITTING |
| EEAC334-49 |  | OIL DRAIN CAP |
| EEAC334-56 |  | COMPRESSION SPRING |

| SNAPON PART NUMBER | IMAGE | DESCRPTION |
|--------------------|---|-------------------------|
| EEAC330-94 |  | TANK PLATE MAGNET |
| EEAC330-96 |  | DRYER FILTER MANIFOLD |
| EEAC330-99 |  | MAGNET FLARED HOLE |
| EEAC330A-1 |  | TANK UNLOCK STICKER 1 |
| EEAC330A-2 |  | TANK UNLOCK STICKER 2 |
| EEAC330A-3 |  | LOCK UNLOCK KEY |
| EEAC330A-4 |  | TANK CENTERING PIN |
| EEAC330A-5 |  | TANK PLATE STOP SCREW |
| EEAC330A-6 |  | TANK PLATE BALL PLUNGER |
| EEAC330-100 |  | 10mm SPACER SCALE |
| EEAC330-102 |  | WARNER STICKER (EN) |
| EEAC330-103 |  | WARNING STICKER (FR) |
| EEAC330-121 |  | UL SWITCH STICKER |
| EEAC330-108 |  | O-RING KIT FILTER DRYER |
| EEAC330-109 |  | LUBE |
| EEAC330-112 |  | O-RING 1/4 CAP SCREW |

| SNAPON PART NUMBER | IMAGE | DESCRIPTION |
|--------------------|---|------------------------------|
| EEAC330-132 |  | 12 PIN MOTHER BOARD CONNCTOR |
| EEAC330-120 |  | POWER SUPPLY COVER |
| EEAC330-119 |  | CONTROL PANEL FIXING BRACKET |
| EEAC330-118 |  | OIL FILL BRACKET |
| EEAC330-117 |  | 1/8 X M24 FITTING |
| EEAC330-16 |  | OIL DRAIN EXTENSION |
| EEAC331-27 |  | STATUS LIGHT WIRING HARNESS |
| EEAC330-128 |  | 1/4 COPPER GASKET |
| EEAC330-129 |  | 3/8 COPPER GASKET |
| EEAC333-21 |  | SNP16 WARNING STICKER (EN) 1 |
| EEAC333-22 |  | SNP16 WARNING STICKER (EN) 2 |
| EEAC333-23 |  | SNP16 WARNING STICKER (FR) 1 |
| EEAC333-24 |  | SNP16 WARNING STICKER (FR) 2 |
| EEAC333-29 |  | MESH SCREEN |
| EEAC333-35 |  | O2 SENSOR |
| EEAC333-18 |  | ANALYZER |
| EEAC333-16 |  | GAS ANALYZER HOSE W/ REDUCER |



Notice: The information contained in this document is subject to change without notice. Snap-on Equipment makes no warranty with regard to this material. Snap-on Equipment shall not be liable for errors contained herein or for incidental consequential damages in connection with furnishings, performance, or use of this material.

This document contains proprietary information which is protected by copyright and patents. All rights are reserved. No part of this document may be photocopied, reproduced, or translated without prior written consent of Snap-on Equipment